

atlantic uk<sup>®</sup>  
architectural hardware  
*the finish matters<sup>®</sup>*



---

0800 9020 486 | [sales@atlanticgb.com](mailto:sales@atlanticgb.com) | [www.atlantichandles.com](http://www.atlantichandles.com)

---



Visit our website to stay up to date with our latest launches and more...



# CONTENTS

---

About Us.....	04
Our Values.....	05

Finishes Overview.....	06
------------------------	----

## Ranges

Millhouse Brass.....	14
Tupai.....	26
Forme.....	52
Oro & Oro.....	72
Senza Pari.....	82
Old English.....	98
Mediterranean.....	118
Status.....	132
CleanTouch.....	150
Cabinet Hardware.....	154
Commercial Hardware.....	192
Ermetika Pocket Doors.....	198
Ironmongery Accessories.....	212

Projects.....	254
---------------	-----

Quick Index.....	264
Index.....	268



STATE OF THE ART WAREHOUSE MANAGEMENT SYSTEM

# ABOUT US

Evolving out of a joinery manufacturing company established in 1989, we are anything but a typical architectural hardware distributor. From our inception in 2008, Atlantic UK has been driven by a singular mission - to make finished focussed coordinated ironmongery easily accessible from stock.

We constantly strive to be the most forward thinking, innovative and customer centric supplier in architectural hardware. How do we do this? We ask questions, we listen to feedback, we analyse, we act and we will always strive to meet our customers' needs.

We believe in providing a comprehensive range of high-quality products. As the finish experts within the architectural ironmongery industry, we pride ourselves in colour matching any item of door furniture and accessory.

Our products are manufactured to the highest standards, providing that distinctive finishing touch to your project. Encompassing nine stunning ranges, choose from the versatile and vintage Old English, to our sleek and contemporary Forme Italian range. Including over 110 different designs and 32 beautiful finishes, you will find something to compliment every style of interior.

At Atlantic UK, we believe ***the finish matters*** - whether it's the final touch on a project or the texture and quality of a product. For us, the perfect finish is a complete set of complementary, matching products. From levers and hinges to latches, locks, and door stops - remember, the finish matters!

All of our Door Levers and Knobs come with a 10 year mechanical warranty (Subject to Terms & Conditions).

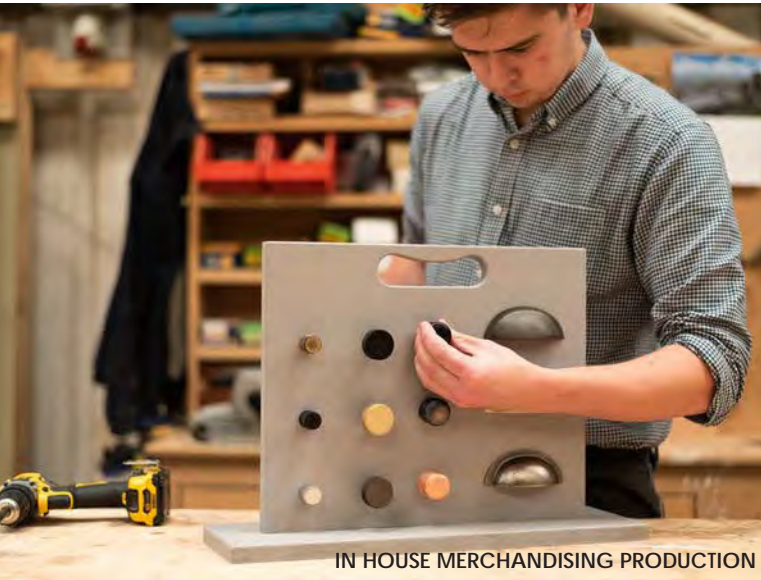

IN HOUSE MERCHANDISING PRODUCTION



MODERN SHOWROOM OPENED 2023



NEW WAREHOUSE OPENED 2024

# OUR VALUES



## PASSION

Passion and creativity drive us to excel at everything we do. We believe in what we provide and the value it brings, whilst striving to do our best and discover just how good we can really be!



## INTEGRITY

Integrity, honesty, respect, and trust are core to our values. When we make a commitment, we follow through.



## COMMITMENT

Customer commitment is at the heart of who we are. As a customer-centric team, we consistently go the extra mile.

We are equally dedicated to one another, fostering a strong, positive, and respectful culture. Our commitment extends to being the ultimate finish experts, defining style and creating desire.



## INNOVATION

Continuous improvement and innovation drive us to consistently grow and evolve, meeting the needs of our clients, team members, and the local community.

We approach each day with a commitment to learning, growth, and challenging ourselves.



# Make *the finish* the start of your design journey...

Here at Atlantic UK, we understand that the finishing touches make all the difference when it comes to interior design. That's why we offer a wide range of complementary ironmongery, including levers, hinges, latches, locks, and door handles. From sumptuous Satin Brass to sleek Matt Black, our finish options are designed to cater to every taste and project.

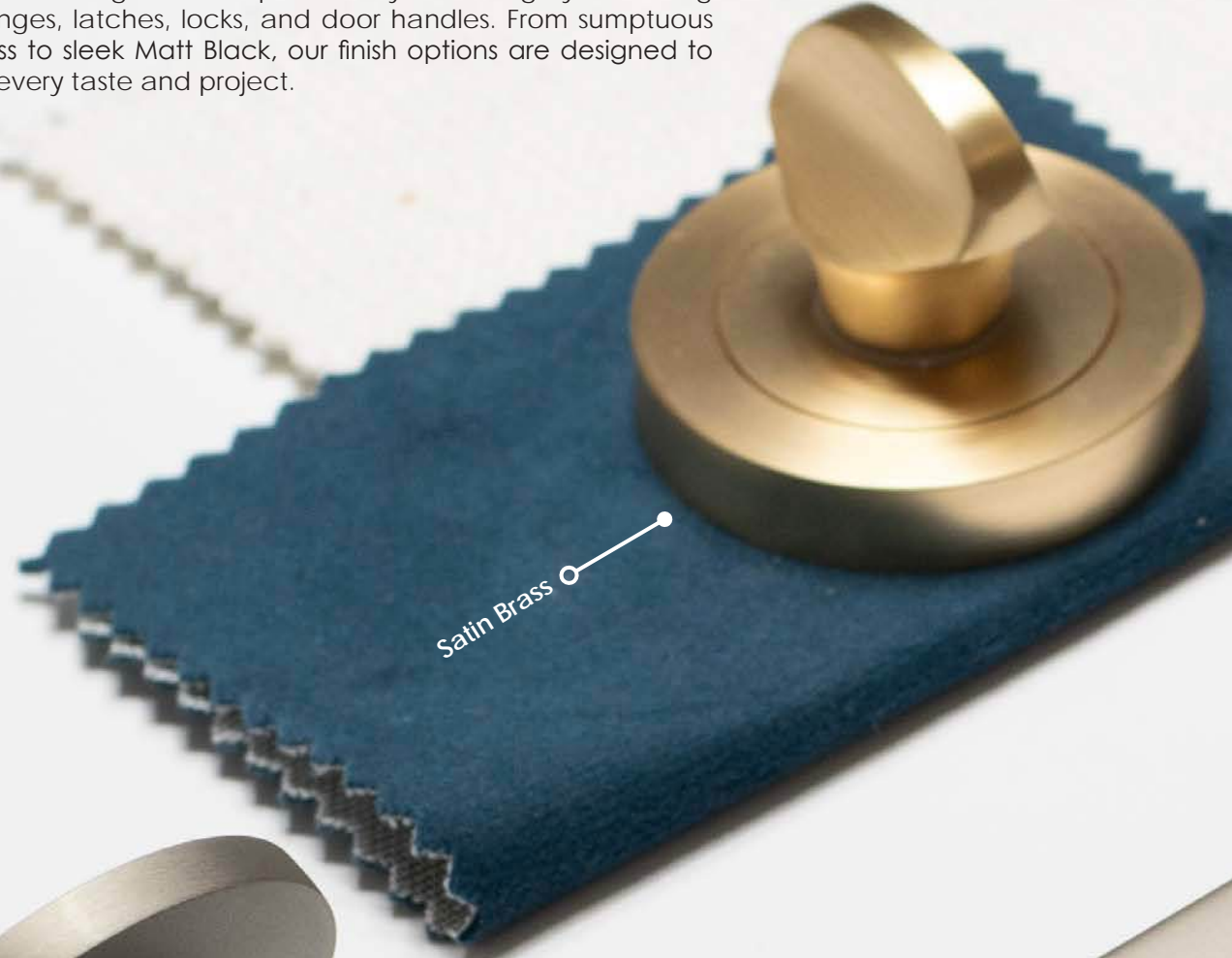

Satin Brass



Pearl Nickel

TUPAI



Matt Black

Black Nickel

# FINISHES

At Atlantic UK, we know that little details can make a big difference in interior design. We believe the right finish can completely transform the look and feel of a space. That's why we offer a wide range of complementary ironmongery - from levers to locks, we've got you covered. With over 20 standard finishes, our collection of product finishes is designed to accommodate every type of style! Whether adding a touch of opulence or creating a more modern, understated look, our diverse range of finishes ensures that you'll find the perfect match for your design vision!

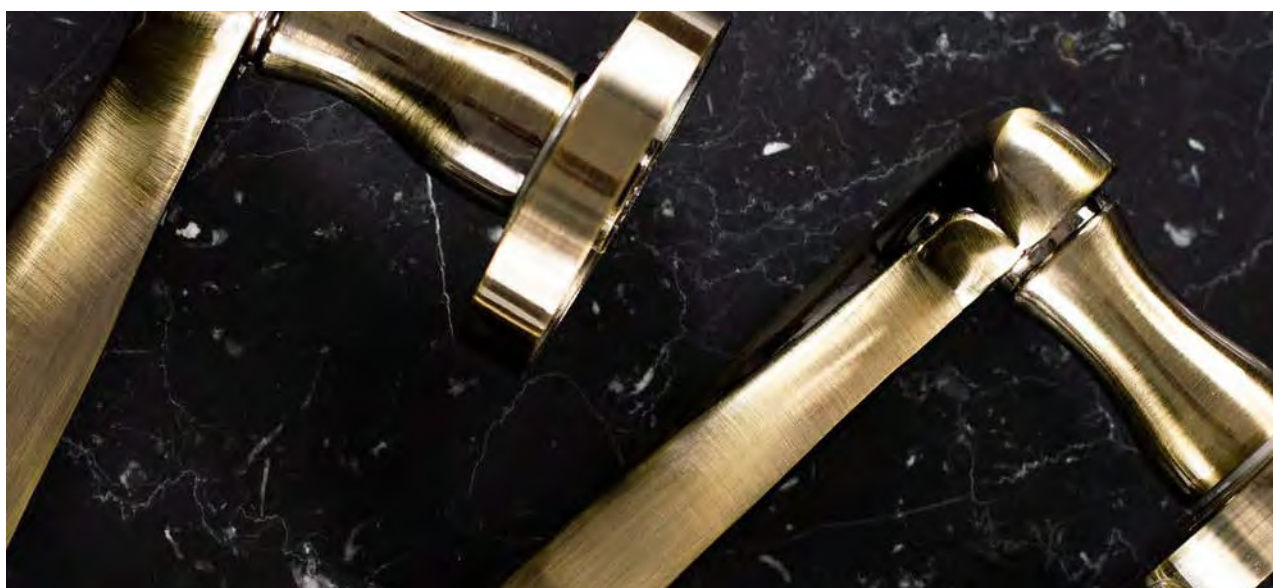

## **ANTIQUE BRASS (AB)**

Our Antique Brass finish brings a timeless elegance to any interior space. This sophisticated finish combines rich, warm tones with subtle, aged patinas, creating a look that is both classic and versatile. Ideal for period properties and contemporary homes alike, the Antique Brass finish adds a touch of refined luxury and craftsmanship to your doors and furniture.

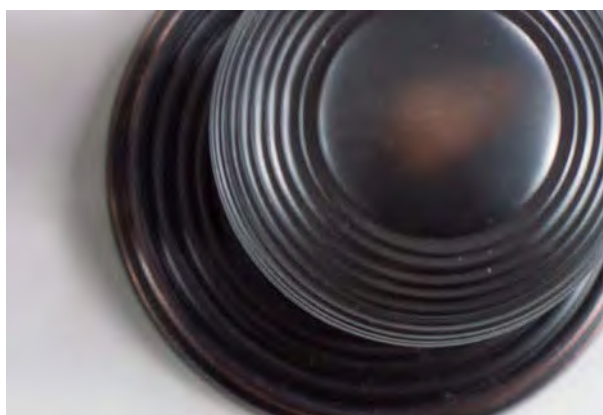

## **ANTIQUE COPPER (AC)**

With warm, reddish-brown hues and a rich tone, Antique Copper adds a luxurious touch and a sense of artisan craftsmanship.

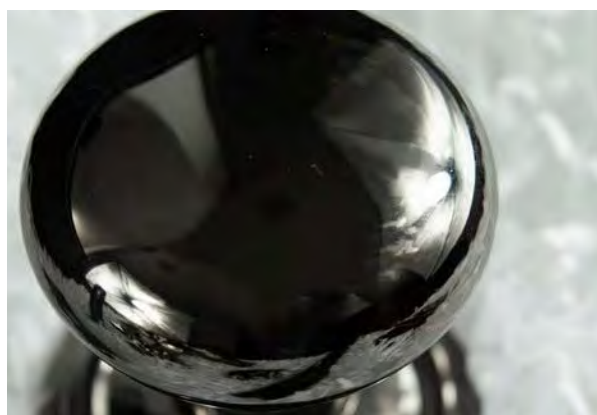

## **BLACK NICKEL (BN)**

With its deep, lustrous shine and sleek appearance, Black Nickel adds a touch of luxury and refinement to any space.





**DISTRESSED SILVER (DS)**

With a unique weathered and textured appearance, our Distressed Silver finish adds character and depth, creating an elevated rustic and timeless look.

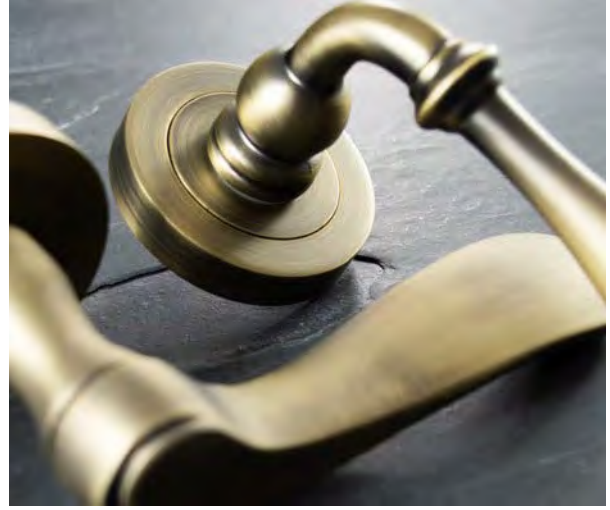

**MATT ANTIQUE BRASS (MAB)**

Combining the timeless charm of Antique Brass with a contemporary matt texture, this finish creates a look that is both classic and modern.



**MATT BLACK (MB)**

Offering a bold, modern statement for any interior, its sleek, non-reflective surface, provides a sophisticated and contemporary look that complements a wide range of design styles.



**MATT GUN METAL (MBN)**

With its deep, muted tones and matt surface, this finish offers a sophisticated and contemporary aesthetic that complements a wide array of design styles, from industrial to modern chic.



**POLISHED BRASS (PB)**

With its bright, reflective surface and warm golden tones, Polished Brass adds a touch of luxury and refinement to your doors and furniture.



**POLISHED CHROME (PC)**

With a sleek, modern feel and a high-gloss, mirror-like surface, the bright, reflective quality of Polished Chrome creates a contemporary look.



**POLISHED NICKEL (PN)**

Our Polished Nickel finish offers a refined and contemporary look. With a sleek, high-shine surface, it offers a modern twist on traditional silver finishes, creating a timeless modern look.



**POLISHED STAINLESS STEEL (PSS)**

Modern and durable, with a sleek, high-gloss surface. The bright, reflective quality provides a clean and contemporary aesthetic.



**SATIN BRASS (SB)**

Luxurious and timeless with a soft, brushed texture and warm golden hue. This finish provides an elegant, understated glow that adds a touch of sophistication to any interior.



**SATIN CHROME (SC)**

A sleek, contemporary finish with a smooth, brushed texture and cool, muted sheen. This finish exudes modern elegance and subtle sophistication.



**SATIN NICKEL (SN)**

A blend of contemporary sophistication and timeless elegance Satin Nickel has a smooth, brushed texture and subtle, silvery look.



**SATIN STAINLESS STEEL (SSS)**

Combining a modern look with exceptional durability, Satin Stainless Steel offers a sleek, brushed texture with a subtle, elegant sheen.



**URBAN BRONZE (UB)**

Combining warm hues and a brushed texture, Urban Bronze has a striking and versatile look that complements a wide range of design styles, from industrial chic to rustic elegance.



**URBAN DARK BRONZE (UDB)**

A darker and more dramatic take on our Urban Bronze finish. It is rich and luxurious in colour and matt in texture, making it a perfect choice for adding depth and character to an interior.



**URBAN GRAPHITE (UG)**

A deep graphite hue with a unique brushed matt texture, the finish offers a sleek, contemporary aesthetic adding a modern, industrial edge to any interior.



**URBAN SATIN COPPER (USC)**

This unique finish features a smooth, satin texture and rich copper tones that add a touch of contemporary elegance to any interior.



**YESTER BRONZE (YB)**

A unique finish that combines warm, industrial shades of golden brown. Rich in texture, this finish is perfect adding charm and character to any space. The finish works beautifully in a variety of settings, from rustic and vintage-inspired interiors to more modern, eclectic spaces.

# SPECIAL FINISHES

Alongside our collection of standard finishes we also offer a range of special finishes that provide you something a little different.



**BRIGHT POLISHED CHROME (PC)**  
With a smooth mirror-like finish it feels modern and dramatic.



**BRONZE (B)**  
With warm rich tones it feels luxurious and timeless in any space.



**PEARL BLACK (MB)**  
With slightly more sheen than Matt Black, it is subtle and striking.



**PEARL NICKEL (PL)**  
With a soft sheen it has a contemporary elegance that is chic and timeless, suiting a variety of interior styles.



**RAW BRASS / UNLACQUERED BRASS (RB)**  
Embracing the natural state of brass, it can be left to naturally age over time, or be polished to create a shiny luxe finish.



**TITANIUM (TT)**  
A modern metallic hue close to a dark bronze. It combines a timeless appeal with the sleek, industrial feel of metal.

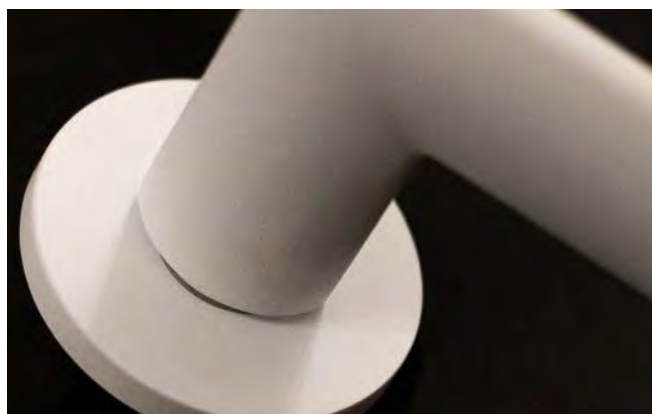

**WHITE (WH)**  
A modern and versatile finish that exudes sophistication, it is an ideal choice for creating a clean, contemporary look.

# DUAL FINISHES

Our collection of dual finishes are the perfect additional design detail. Whether you're looking to create contrast or complement existing elements, these finishes provide a stunning versatile option.

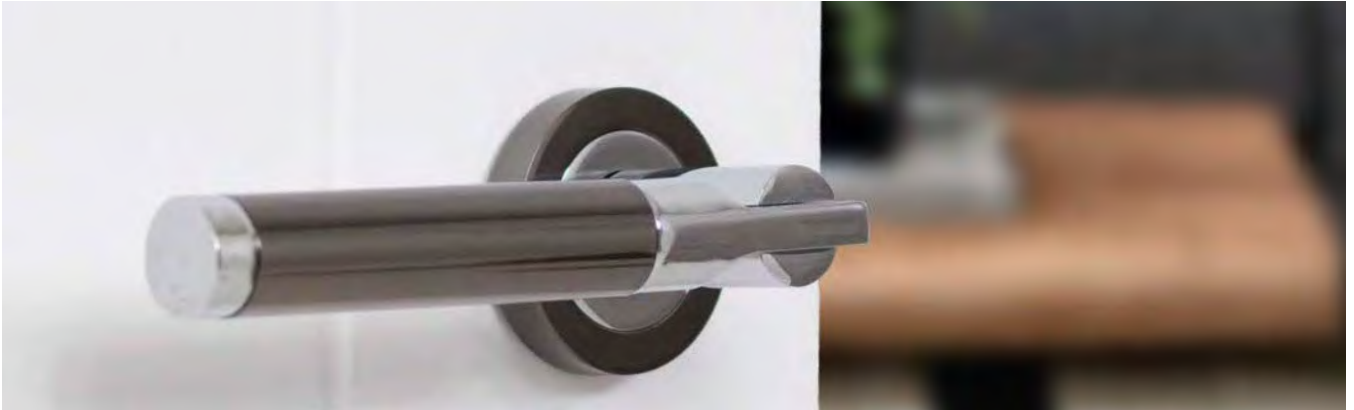

## **BLACK NICKEL/POLISHED CHROME (BNPC)**

A striking combination of lustrous black nickel and mirror-like polished chrome it is a modern and stylish finish, perfect for creating a sleek contemporary look and adding a refined and elegant touch to any space.



## **SATIN CHROME/POLISHED CHROME (SCPC)**

Perfect for a modern contemporary look, it is stylish and sleek, providing a subtle and understated elegance.



## **SATIN NICKEL/CHROME PLATE (SNCP/SNPC)**

A contemporary combination of brushed silvery Nickel and mirror-like Polished Chrome. Perfect for a modern feel.



## **SATIN NICKEL / NICKEL PLATE (SNNP)**

Merging sophisticated brushed Satin Nickel with glamorous Polished Nickel for a modern, contemporary feel.



## **SATIN NICKEL/POLISHED BRASS (SNBP)**

A unique dual colour finish of silvery Satin Nickel and warm golden Polished Brass for a statement look.

# MILLHOUSE BRASS

INDUSTRIAL RESTORATION

Edison Solid Brass Domed Mortice Knob on  
Concealed Fix Rose - Antique Brass



Boulton Solid Brass Mortice Knob on Concealed Fix  
Rose - Antique Brass

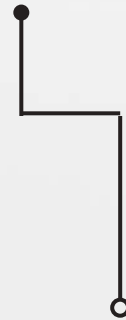

Taking inspiration from architecture and design born from the Industrial Revolution and the latter Art Deco and Bauhaus periods, our Millhouse Brass range has a modern urban chic feel.

All about innovation, the Industrial Revolution and subsequent periods represent a transitional time as progress in industry, technology, and design took centre stage. Millhouse Brass embraces this industrial craftsmanship, adding a contemporary twist to make it the perfect choice for modern and more traditional interiors alike.

Inspired by the dynamic structures and intricate ironwork of prominent architectural landmarks of the time, the range showcases bold and modern designs with a focus on texture and finish.

Millhouse Brass embodies both the innovative spirit and quality craftsmanship of the time, to provide stunning and stylish design-led products.

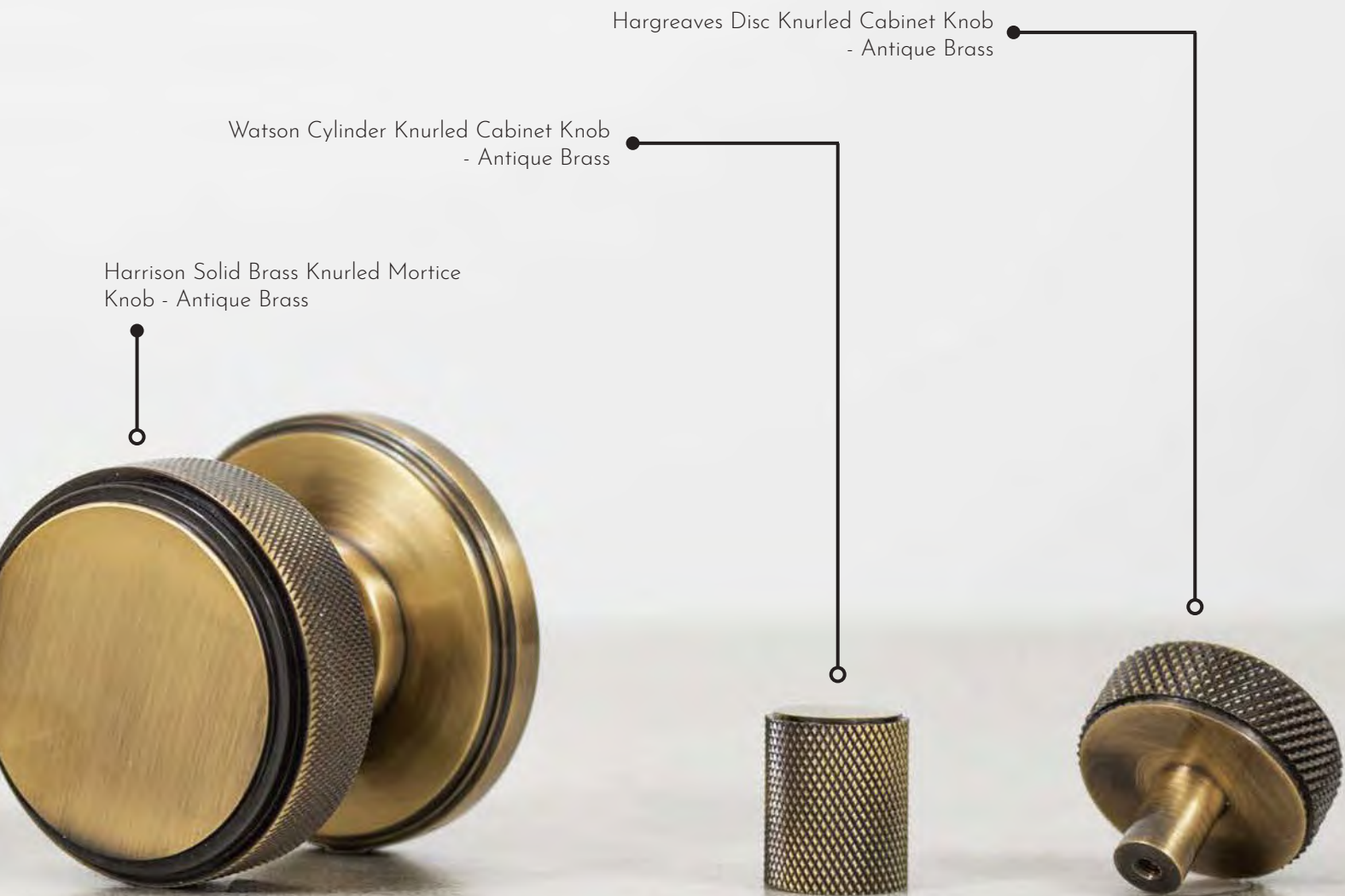

Hargreaves Disc Knurled Cabinet Knob  
- Antique Brass

Watson Cylinder Knurled Cabinet Knob  
- Antique Brass

Harrison Solid Brass Knurled Mortice  
Knob - Antique Brass



HARRISON  
MORTICE KNOB -  
ANTIQUE BRASS

HARGREAVES CABINET  
KNOB - ANTIQUE BRASS





# MILLHOUSE BRASS

---

## INDUSTRIAL RESTORATION

Combining sleek finishes with a contemporary industrial look, our Millhouse Brass collection brings a new twist to a classic authentic style. With a stylish edge, the range is perfect for creating a modern statement.

The collection showcases slim sprung levers for a streamlined look, superior quality solid brass knobs, a new selection of stylish cabinet hardware and everything in between for a complete ironmongery solution for your door or cabinetry.

Designed to capture the essence of urban chic, the range features clean lines, robust materials, and impeccable craftsmanship.



WATSON CABINET  
KNOB - ANTIQUE  
BRASS



OPEN KEY HOLE  
ESCUTCHEON -  
ANTIQUE BRASS



CROMPTON LEVER - YESTER BRONZE

Crompton, the epitome of elegance and luxury. Its precision knurling sets it apart from the rest. A sleek and modern design, it's the perfect touch to any contemporary interior.

# CROMPTON

*Designer Lever Door Handle*

LEVER ON SLIM ROSE - ROUND ROSE | LEVER ON CONCEALED ROSE



Satin Brass (SB)

**MHSR100(finish) CROMPTON LEVER ON 5MM SLIM ROUND ROSE**  
With a beautifully textured knurled bar, the Crompton lever is a statement show piece.

Finishes: MB, PC, SB, SN, UDB, YB  
Matching WC Turn: MHSRKWC(finish)  
Matching Key Esc: MHSRK(finish)  
Matching Euro Esc: MHSRE(finish)  
Matching Latch: AL3(finish)

Base Material: Solid Brass  
Dimensions: A: 51mm B: 143mm  
C: 5mm D: 63mm  
Weight of 1 single lever: 542g

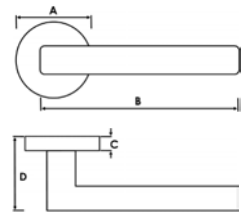

**MHCR100(finish) CROMPTON LEVER ON CONCEALED ROUND ROSE**

Finishes: MB, PC, SN, UDB  
Matching WC Turn: FCRWC(finish)  
Matching Key Esc: FCRK(finish)

Matching Euro Esc: FCRE(finish)  
Note: Concealed rose levers can only be used with AGB magnetic locks.

forme

## FINISHES:



MATT BLACK (MB)



POLISHED CHROME (PC)



SATIN BRASS (SB)



SATIN NICKEL (SN)



URBAN DARK BRONZE (UDB)



YESTER BRONZE (YB)



Looking to add a contemporary industrial touch to your space? Look no further than Mason's intricate knurled pattern. The epitome of industrial luxe, this sleek and minimalistic design makes a bold statement.

# MASON

## Designer Lever Door Handle

LEVER ON SLIM ROSE - ROUND ROSE | LEVER ON CONCEALED ROSE



Matt Black (MB)

### MHSR500(finish) MASON LEVER ON 5MM SLIM ROUND ROSE

This industrial themed design is a perfect solution to any restored interior.

Finishes: MB, PC, SB, SN, UDB, YB  
 Matching WC Turn: MHSRKWC(finish)  
 Matching Key Esc: MHSRK(finish)  
 Matching Euro Esc: MHSRE(finish)  
 Matching Latch: AL3(finish)

Base Material: Solid Brass  
 Dimensions: A: 51mm B: 131.5mm  
 C: 5mm D: 56mm  
 Weight of 1 single lever: 425g

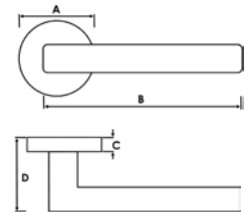

### MHCR500(finish) MASON LEVER ON CONCEALED ROUND ROSE

Finishes: MB, PC, SN, UDB  
 Matching WC Turn: FCRWC(finish)  
 Matching Key Esc: FCRK(finish)

Matching Euro Esc: FCRE(finish)  
 Note: Concealed rose levers can only be used with AGB magnetic locks.

forme

## FINISHES:



MATT BLACK (MB)



POLISHED CHROME (PC)



SATIN BRASS (SB)



SATIN NICKEL (SN)



URBAN DARK BRONZE (UDB)



YESTER BRONZE (YB)

MILLHOUSE BRASS

An industrial inspired design. Cartwright captures the classic feel of Bauhaus levers with an added contemporary twist. With 3 stunning finishes to choose from, there's something to suit every taste.

# CARTWRIGHT

*Designer Lever Door Handle*

LEVER ON ROUND ROSE | LEVER ON CONCEALED ROSE



Satin Nickel (SN)

**MHR200(finish) CARTWRIGHT LEVER ON 10MM ROUND ROSE**  
A stunning, contemporary designer lever with intricate knurled details.

Finishes: MB, PC, SN  
Matching WC Turn: MHRWC(finish)  
Matching Key Esc: MHRK(finish)  
Matching Euro Esc: MHRE(finish)  
Matching Latch: AL3(finish)

Base Material: Solid Brass & Zinc  
Dimensions: A: 52mm B: 122mm  
C: 10mm D: 72mm  
Weight of 1 single lever: 400g

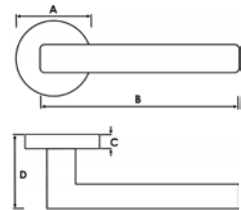

**MHCR200(finish) CARTWRIGHT LEVER ON CONCEALED ROUND ROSE**

Finishes: MB, PC, SN  
Matching WC Turn: FCRWC(finish)  
Matching Key Esc: FCRK(finish)

Matching Euro Esc: FCRE(finish)  
Note: Concealed rose levers can only be used with AGB magnetic locks.

## FINISHES:



MATT BLACK (MB)



POLISHED CHROME (PC)



SATIN NICKEL (SN)

Exuding an industrial chic feel, our Stephenson lever adds a touch of glamour, perfect for any minimalist interior. With modern linear knurling, it has a contemporary detailed edge.

# STEPHENSON

*Designer Lever Door Handle*

LEVER ON SLIM ROSE - ROUND ROSE | LEVER ON CONCEALED ROSE

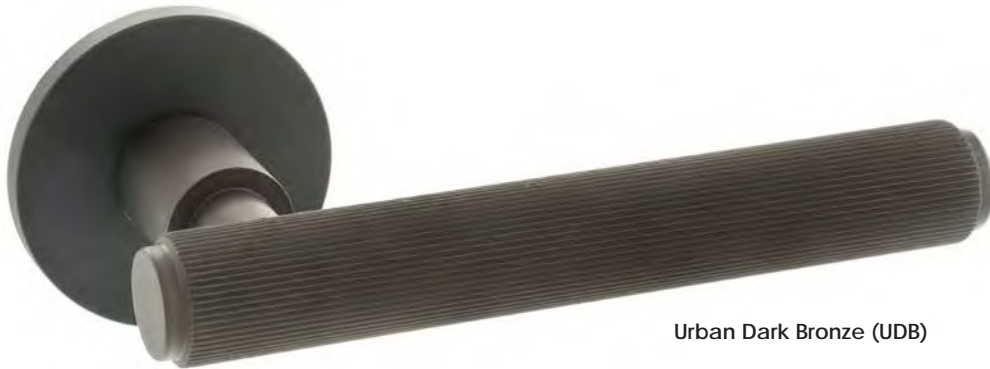

Urban Dark Bronze (UDB)

**MHSR250(finish) STEPHENSON LEVER ON 5MM SLIM ROUND ROSE**  
A contemporary lever with stunning linear details.

Finishes: MB, PC, SB, SN, UDB, YB  
Matching WC Turn: MHSRLWC(finish)  
Matching Key Esc: MHSRK(finish)  
Matching Euro Esc: MHSRE(finish)  
Matching Latch: AL3(finish)

Base Material: Solid Brass  
Dimensions: A: 51mm B: 130mm  
C: 5mm D: 62mm  
Weight of 1 single lever: 415g

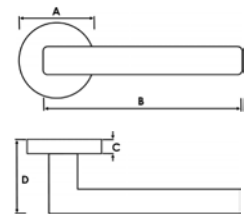

**MHCR250(finish) STEPHENSON LEVER ON CONCEALED ROUND ROSE**

Finishes: MB, PC, SN, UDB  
Matching WC Turn: FCRWC(finish)  
Matching Key Esc: FCRK(finish)

Matching Euro Esc: FCRE(finish)  
Note: Concealed rose levers can only be used with AGB magnetic locks.

forme

## FINISHES:



MATT BLACK (MB)



POLISHED CHROME (PC)



SATIN BRASS (SB)



SATIN NICKEL (SN)



URBAN DARK BRONZE (UDB)

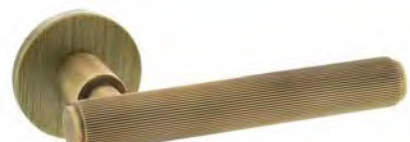

YESTER BRONZE (YB)

MILLHOUSE BRASS

Adding a modern twist to a classic design, our Boulton knob is stylish and contemporary. Choose from 6 stunning finishes including sleek Matt Black and classic Antique Brass. For an added luxurious touch, it now comes in a solid back version.



# BOULTON

*Designer Mortice Knob* | MORTICE KNOB - ROUND BACKPLATE



Polished Nickel (PN)

**MH350SMK(finish) BOULTON STEPPED MORTICE KNOB**

A contemporary take on a traditional style with stunning details.

Finishes: AB, MB, PN, SB, SN, UDB  
 Matching WC Turn: MHOWC(finish)  
 Matching Key Esc: MHRKE(finish)  
 Matching Latch: AL3(finish) or AL4(finish)  
 Base Material: Solid Brass  
 Concealed Fix Rose

Unsprung  
 Dimensions: Knob Diameter: 60mm  
 Projection: 60mm  
 Rose Diameter: 65mm  
 Weight of 1 single knob: 400g



**MH350SMK(finish)SOLID BOULTON SOLID BRASS STEPPED MORTICE KNOB**

For an added luxurious touch, our Boulton knob now comes in a solid back version.

Finishes: AB, MB, PN, SB, SN, UDB

## FINISHES:



ANTIQUÉ BRASS (AB)



MATT BLACK (MB)



POLISHED NICKEL (PN)



SATIN BRASS (SB)



SATIN NICKEL (SN)



URBAN DARK BRONZE (UDB)



Featuring a versatile domed mushroom design, our Edison knob is the perfect choice for adding a touch of vintage charm to a space. With 6 finishes to choose from there's something to suit every interior.

# EDISON

*Designer Mortice Knob* | MORTICE KNOB - ROUND BACKPLATE



Urban Dark Bronze (UDB)

MILLHOUSE BRASS

## MH400DMK(finish) EDISON DOMED MUSHROOM MORTICE KNOB

A classic design with a modern twist.

Finishes: AB, MB, PN, SB, SN, UDB  
Matching WC Turn: MHOWC(finish)  
Matching Key Esc: MHRKE(finish)  
Matching Latch: AL3(finish) or AL4(finish)  
Base Material: Solid Brass  
Concealed Fix Rose

Unsprung  
Dimensions: Knob Diameter: 63mm  
Projection: 73mm  
Rose Diameter: 65mm  
Weight of 1 single knob: 457g

## FINISHES:



ANTIQUÉ BRASS (AB)



MATT BLACK (MB)



POLISHED NICKEL (PN)



SATIN BRASS (SB)



SATIN NICKEL (SN)



URBAN DARK BRONZE (UDB)

With stunning knurled details, our Harrison knob seamlessly blends modern craftsmanship with timeless elegance, bringing a contemporary urban feel to a classic design. The intricate knurling adds texture and depth, creating an elevated tactile experience that enhances any space.



# HARRISON

*Designer Mortice Knob* | MORTICE KNOB - ROUND BACKPLATE



Satin Nickel (SN)

**MH450KSMK(finish) HARRISON KNURLED STEPPED MORTICE KNOB**

A modern, industrial style knob with statement knurled texture.

Finishes: AB, MB, SB, SN	Unsprung
Matching WC Turn: MHOWC(finish)	Dimensions: Knob Diameter: 60mm
Matching Key Esc: MHRKE(finish)	Projection: 58mm
Matching Latch: AL3(finish) or AL4(finish)	Rose Diameter: 65mm
Base Material: Solid Brass	Weight of 1 single knob: 360g
Concealed Fix Rose	



**MH450KSMK(finish) SOLID HARRISON KNURLED SOLID BRASS STEPPED MORTICE KNOB**

For an added luxurious touch, choose our solid back version.

Finishes: AB, MB, SB, SN

## FINISHES:



ANTIQUE BRASS (AB)



MATT BLACK (MB)



SATIN BRASS (SB)



SATIN NICKEL (SN)



# ACCESSORIES

## ESCUTCHEONS | WC TURN & RELEASE



SB



### MHSRE(finish) EURO ESCUTCHEON 5MM SLIM ROUND

Finishes: MB, PB, PC, PN, SB, SN, UDB, YB

Base Material: Solid Brass

Sold with matching wood screws.

Dimensions: Width/Height: 51mm Depth: 5mm

Unit: Sold in Pairs



MB



### MHSRK(finish) KEY ESCUTCHEON 5MM SLIM ROUND

Finishes: MB, PB, PC, PN, SB, SN, UDB, YB

Base Material: Solid Brass

Sold with matching wood screws.

Dimensions: Width/Height: 51mm Depth: 5mm

Unit: Sold in Pairs



MB



### MHRE(finish) EURO ESCUTCHEON ROUND

Finishes: MB, PC, SN

Base Material: Zinc

Sold with matching wood screws.

To suit Cartwright Lever.

Dimensions: Width/Height: 51mm

Unit: Sold in Pairs



MB



### MHRK(finish) KEY ESCUTCHEON ROUND

Finishes: MB, PC, SN

Base Material: Zinc

Sold with matching wood screws.

To suit Cartwright Lever.

Dimensions: Width/Height: 51mm

Unit: Sold in Pairs



SB



### MHRKE(finish) OPEN KEY ESCUTCHEON ROUND

Finishes: AB, MB, PN, SB, SN, UDB

Base Material: Solid Brass

Sold with matching wood screws.

To suit Boulton, Edison & Harrison Mortice Knobs.

Dimensions: Rose Width/Height: 42mm

Unit: Sold in Pairs



MB



### MHSRKWC(finish) KNURLED WC TURN & RELEASE 5MM SLIM ROUND

To suit Crompton & Mason Levers.

Finishes: MB, PC, SB, SN, UDB, YB

Base Material: Solid Brass

Sold with matching wood screws.

Dimensions: Rose Width/Height: 50mm

Projection: 30mm



MB



### MHRWC(finish) WC TURN & RELEASE ROUND

Finishes: MB, PC, SN

Base Material: Zinc

Sold with matching wood screws.

To suit Cartwright Lever.

Dimensions: Rose Width/Height: 51mm

Projection: 40mm



SB



### MHSRLWC(finish) LINEAR WC TURN & RELEASE 5MM SLIM ROUND

To suit Stephenson Lever.

Finishes: MB, PC, SB, SN, UDB, YB

Base Material: Solid Brass

Sold with matching wood screws.

Dimensions: Rose Width/Height: 50mm

Projection: 30mm



SB



### MHSRWC(finish) WC TURN & RELEASE 5MM SLIM ROUND

Finishes: MB, PB, PC, PN, SB, SN, UDB, YB

Base Material: Solid Brass

Sold with matching wood screws.

Dimensions: Rose Width/Height: 51mm

Projection: 29mm



MB



### MHOWC(finish) WC TURN & RELEASE ROUND

To suit Boulton, Edison & Harrison Mortice Knobs.

Finishes: AB, MB, PN, SB, SN, UDB

Base Material: Solid Brass

Sold with matching wood screws.

Dimensions: Rose Width/Height: 43mm

Projection: 41mm

Millhouse Brass Cabinet Hardware Range is also available. See page 154-188.

# TUPAI®

A premium collection of sleek, modern and timeless designs. Create a design statement with our Tupai range. Manufactured to the highest of standards, our Tupai levers are the perfect stylish and contemporary finishing touch to your project.

VERSALINE / RETALINE  
WC TURN & RELEASE -  
SATIN CHROME



CURVA / QUADRALINE  
SQUARE ROSE EURO  
ESCUTCHEON - SATIN  
CHROME



## OUR TUPAI RANGE INCLUDES:



Premium solid brass designer levers on a 5mm slimline rose.  
Page 28-37



Luxurious designer look with bespoke rectangular rose.  
Page 38-43



Customisable lever - from lever finish to decorative plate finish.  
Page 44-45

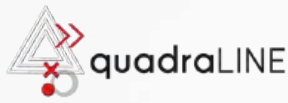

Beautiful simplistic style with sleek, straight lines.  
Page 46-47



From classic looks that never go out of style to bold contemporary designs.  
Page 48-50



VERSALINE TOBAR LEVER - SATIN CHROME

# TUPAI®



Our premium Tupai 5S Line designer levers feature a 5mm slimline sprung rose. These timeless designs are enhanced by a selection of elegant finishes which complete any minimalist look.

- Minimalist Designs
- Slim 5mm Rose - Ultimate Modernity
- Elegant Finishes
- Premium Solid Brass Designer Levers
- Beautiful Simplistic Style





TUPAI

○  
● 5S LINE TAVIRA LEVER - PEARL NICKEL

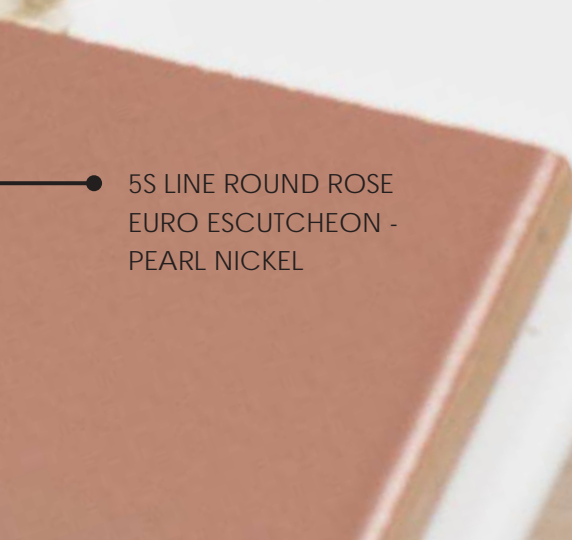

● 5S LINE ROUND ROSE  
EURO ESCUTCHEON -  
PEARL NICKEL

# TORRAO

## Designer Lever Door Handle

LEVER ON SLIM ROSE - ROUND ROSE | LEVER ON CONCEALED ROSE



Titanium (TT)

### T1967R5S(finish) TORRAO LEVER ON 5MM SLIM ROUND ROSE

A stylish and sleek lever.

Finishes: MB, PC, PL, SC, TT (Branded Levers)  
 Finishes: MB, PC, PL, RB, TT, WH (Unbranded Levers - **XT1967R5S(finish)**)  
 Matching WC Turn: TWCR5S(finish)  
 Matching Key Esc: TESCKR5S(finish)

Matching Euro Esc: TESCER5S(finish)  
 Matching Latch: AL3(finish)  
 Base Material: Solid Brass  
 Dimensions:  
 A: 52mm B: 118mm C: 5mm D: 58mm

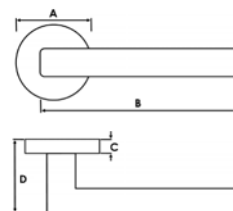

### T1967CR(finish) TORRAO LEVER ON CONCEALED ROUND ROSE

Finishes: MB, PC, PL, SC, TT, WH  
 Matching WC Turn: FCRWC(finish)  
 Matching Key Esc: FCRK(finish)

Matching Euro Esc: FCRE(finish)  
 Note: Concealed rose levers can only be used with AGB magnetic locks.

## FINISHES:



PEARL BLACK (MB)



BRIGHT POLISHED CHROME (PC)



PEARL NICKEL (PL)



UNLACQUERED BRASS / RAW BRASS (RB)  
UNBRANDED ONLY



SATIN CHROME (SC)



WHITE (WH)  
UNBRANDED ONLY



TITANIUM (TT)

# TAVIRA

## Designer Lever Door Handle

LEVER ON SLIM ROSE - ROUND ROSE | LEVER ON CONCEALED ROSE



Pearl Black (MB)

### T3098R5S(finish) TAVIRA LEVER ON 5MM SLIM ROUND ROSE

An timeless, modern design.

Finishes: MB, PC, PL, SC, TT (Branded Levers)  
 Finishes: MB, PC, RB, TT, WH (Unbranded Levers - **XT3098R5S(finish)**)

Matching WC Turn: TWCR5S(finish)  
 Matching Key Esc: TESCKR5S(finish)  
 Matching Euro Esc: TESCER5S(finish)

Matching Latch: AL3(finish)  
 Base Material: PC, RB - Brass  
 TT, PL, SC, MB, WH - Zamak (rose - solid brass)  
 Dimensions:  
 A: 52mm B: 121mm C: 5mm D: 66mm

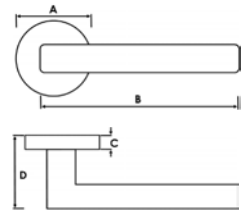

### T3098CR(finish) TAVIRA LEVER ON CONCEALED ROUND ROSE

Finishes: MB, PC, PL, SC, TT, WH  
 Matching WC Turn: FCRWC(finish)  
 Matching Key Esc: FCRK(finish)

Matching Euro Esc: FCRE(finish) Note:  
 Concealed rose levers can only be used with  
 AGB magnetic locks.

## FINISHES:



PEARL BLACK (MB)



BRIGHT POLISHED CHROME (PC)



PEARL NICKEL (PL)



UNLACQUERED BRASS / RAW BRASS (RB)  
 UNBRANDED ONLY



SATIN CHROME (SC)



WHITE (WH)  
 UNBRANDED ONLY



TITANIUM (TT)



# COVAS

## Designer Lever Door Handle

LEVER ON SLIM ROSE - ROUND & SQUARE ROSE | LEVER ON CONCEALED ROSE



Unlacquered Brass / Raw Brass (RB)

**XT4071R5S(finish) COVAS** LEVER ON 5MM SLIM ROUND ROSE  
A contemporary lever with thoughtful design details.

Finishes: MB, RB (Unbranded Levers)  
Matching WC Turn: XTWCR5S(finish)  
Matching Key Esc: XTESCKR5S(finish)  
Matching Euro Esc: XTESCER5S(finish)

Matching Latch: AL3(finish)  
Base Material: Solid Brass  
Dimensions:  
A: 52mm B: 127mm C: 5mm D: 59mm

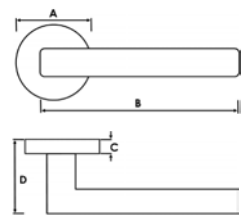

**XT4071CR(finish) COVAS** LEVER ON CONCEALED ROUND ROSE

Finishes: MB  
Matching WC Turn: FCRWC(finish)  
Matching Key Esc: FCRK(finish)

Matching Euro Esc: FCRE(finish)  
Note: Concealed rose levers can only be used with AGB magnetic locks.

## FINISHES:



UNLACQUERED BRASS / RAW BRASS (RB)



PEARL BLACK (MB)



Pearl Black (MB)

**XT4071S5S(finish) COVAS** LEVER ON 5MM SLIM SQUARE ROSE  
Angular and striking with a stunning slimline rose.

Finishes: MB, RB (Unbranded Levers)  
Matching WC Turn: XTWCS5S(finish)  
Matching Key Esc: XTESCKS5S(finish)  
Matching Euro Esc: XTESCESS(finish)

Matching Latch: AL3(finish)  
Base Material: Solid Brass  
Dimensions:  
A: 52mm B: 127mm C: 5mm D: 59mm

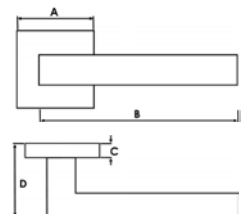

## FINISHES:



UNLACQUERED BRASS / RAW BRASS (RB)



PEARL BLACK (MB)



# COVELA

## Designer Lever Door Handle

LEVER ON SLIM ROSE - ROUND & SQUARE ROSE | LEVER ON CONCEALED ROSE



Unlacquered Brass / Raw Brass (RB)

**XT4002R5S(finish) COVELA LEVER ON 5MM SLIM ROUND ROSE**  
Minimalist lever with a designer twist.

Finishes: RB, TT, WH (Unbranded Lever)  
Matching WC Turn: XTWCR5S(finish)  
Matching Key Esc: XTESCKR5S(finish)  
Matching Euro Esc: XTESCER5S(finish)

Matching Latch: AL3(finish)  
Base Material: Solid Brass  
Dimensions:  
A: 52mm B: 132mm C: 5mm D: 64mm

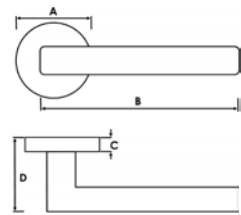

**XT4002CR(finish) COVELA LEVER ON CONCEALED ROUND ROSE**

Finishes: TT, WH  
Matching WC Turn: FCRWC(finish)  
Matching Key Esc: FCRK(finish)

Matching Euro Esc: FCRE(finish)  
Note: Concealed rose levers can only be used with AGB magnetic locks

### FINISHES:

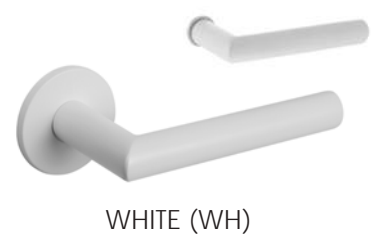

**XT4002S5S(finish) COVELA LEVER ON 5MM SLIM SQUARE ROSE**  
Covela on a square rose is the perfect contemporary lever.

Finishes: RB, TT, WH (Unbranded Lever)  
Matching WC Turn: XTWCS5S(finish)  
Matching Key Esc: XTESCKS5S(finish)  
Matching Euro Esc: XTESCESS(finish)

Matching Latch: AL3(finish)  
Base Material: Solid Brass  
Dimensions:  
A: 52mm B: 132mm C: 5mm D: 64mm

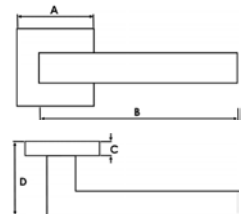

### FINISHES:



# PORTEL

*Designer Lever Door Handle*

LEVER ON SLIM ROSE - ROUND ROSE

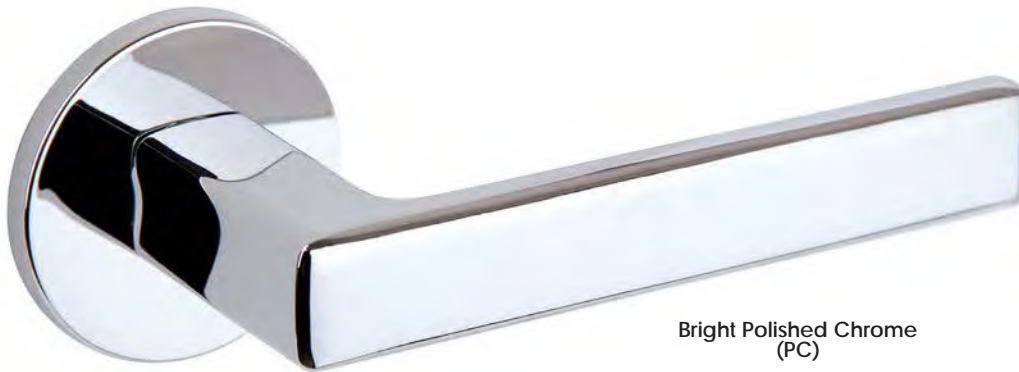

Bright Polished Chrome (PC)

**XT3095R5S(finish)** PORTEL LEVER ON 5MM SLIM ROUND ROSE  
A considered design with a modern feel.

Finishes: PC, RB (Unbranded Lever)  
Matching WC Turn: XTWCR5S(finish)  
Matching Key Esc: XTESCKR5S(finish)  
Matching Euro Esc: XTESCER5S(finish)

Matching Latch: AL3(finish)  
Base Material: Solid Brass  
Dimensions:  
A: 52mm B: 130mm C: 5mm D: 51mm

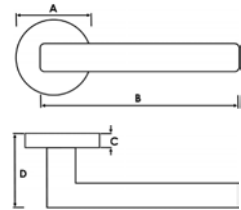

## FINISHES:



BRIGHT POLISHED CHROME (PC)



UNLACQUERED BRASS / RAW BRASS (RB)

# PORTEL

## Designer Lever Door Handle

LEVER ON SLIM ROSE - SQUARE ROSE | LEVER ON CONCEALED ROSE

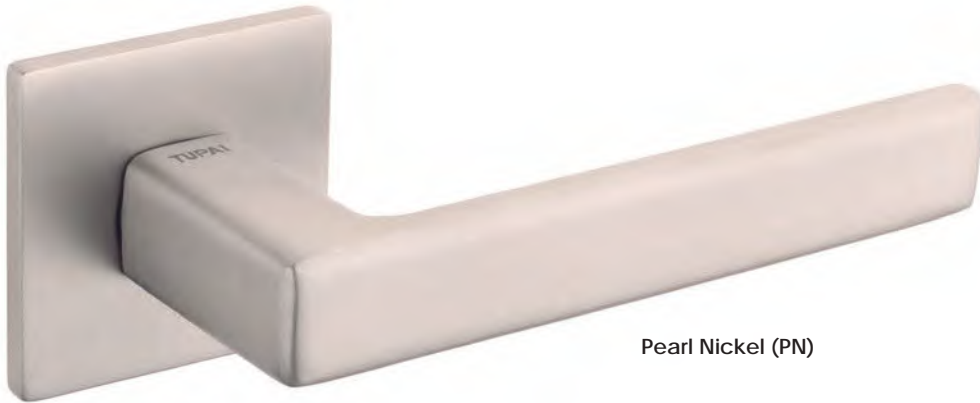

Pearl Nickel (PN)

**T3095S5S(finish) PORTEL LEVER ON 5MM SLIM SQUARE ROSE**  
Offering sleek, straight lines, Portel is perfect for creating a contemporary feel.

Finishes: MB, PC, PL, SC, TT (Branded Lever)  
Finishes: PC, RB (Unbranded Levers -  
**XT3095S5S(finish)**)  
Matching WC Turn: TWCS5S(finish)  
Matching Key Esc: TESCKS5S(finish)

Matching Euro Esc: TESCES5S(finish)  
Matching Latch: AL3(finish)  
Base Material: Solid Brass  
Dimensions:  
A: 52mm B: 130mm C: 5mm D: 51mm

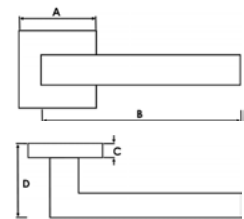

**T3095CS(finish) PORTEL LEVER ON CONCEALED SQUARE ROSE**

Finishes: MB, PC, PL, SC, TT  
Matching WC Turn: FCSWC(finish)  
Matching Key Esc: FCSK(finish)

Matching Euro Esc: FCSE(finish)  
Note: Concealed rose levers can only be used with AGB magnetic locks.

## FINISHES:



PEARL BLACK (MB)



BRIGHT POLISHED CHROME (PC)



PEARL NICKEL (PL)



UNLACQUERED BRASS / RAW  
BRASS (RB)  
UNBRANDED ONLY



SATIN CHROME (SC)



TITANIUM (TT)

**TUPAI**

# CANHA

*Designer Lever Door Handle*

LEVER ON SLIM ROSE - SQUARE ROSE | LEVER ON CONCEALED ROSE



Titanium (TT)

**T4007S5S(finish) CANHA LEVER ON 5MM SLIM SQUARE ROSE**  
A timeless and classic design with a contemporary feel.

Finishes: MB, PC, PL, SC, TT (Branded Lever)  
Matching WC Turn: TWCS5S(finish)  
Matching Key Esc: TESCKS5S(finish)  
Matching Euro Esc: TESCES5S(finish)  
Matching Latch: AL3(finish)

Base Material: Solid Brass  
Branded Lever  
Dimensions:  
A: 52mm B: 138mm C: 5mm D: 54mm

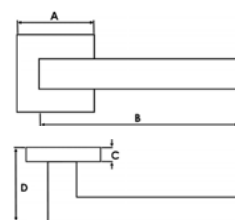

**T4007CS(finish) CANHA LEVER ON CONCEALED SQUARE ROSE**

Finishes: MB, PC, PL, SC, TT  
Matching WC Turn: FCSWC(finish)  
Matching Key Esc: FCSK(finish)

Matching Euro Esc: FCSE(finish)  
Note: Concealed rose levers can only be used with AGB magnetic locks.

## FINISHES:



PEARL BLACK (MB)



BRIGHT POLISHED CHROME (PC)



PEARL NICKEL (PL)



SATIN CHROME (SC)



TITANIUM (TT)

# ACCESSORIES

ESCUTCHEONS - ROUND & SQUARE ROSE | WC TURN & RELEASE - ROUND & SQUARE ROSE

## TESCKR5S(finish) KEY ESCUTCHEON 5MM SLIM ROUND

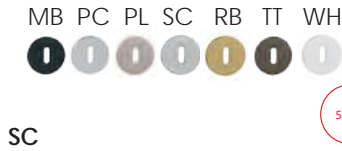

SC



Finishes: MB, PC, PL, SC, RB, TT, WH  
 Base Material: Solid Brass  
 Sold only with bolt through fixings.  
 Can be fitted to all Atlantic locks only when using screws.  
 Screws not supplied with escutcheon.  
 Dimensions: Width/Height: 52mm Depth: 5mm  
 Unit: Sold in Pairs

## TESCER5S(finish) EURO ESCUTCHEON 5MM SLIM ROUND



SC



Finishes: MB, PC, PL, SC, RB, TT, WH  
 Base Material: Solid Brass  
 Sold only with bolt through fixings.  
 Can be fitted to all Atlantic locks only when using screws.  
 Screws not supplied with escutcheon.  
 Compatible with Atlantic Euro Mortice locks, DIN Locks and magnetic locks.  
 Dimensions: Width/Height: 52mm Depth: 5mm  
 Unit: Sold in Pairs

## TESCKS5S(finish) KEY ESCUTCHEON 5MM SLIM SQUARE



SC



Finishes: MB, PC, PL, SC, RB, TT, WH  
 Base Material: Solid Brass  
 Sold only with bolt through fixings.  
 Can be fitted to all Atlantic locks only when using screws.  
 Screws not supplied with escutcheon.  
 Dimensions: Width/Height: 52mm Depth: 5mm  
 Unit: Sold in Pairs

## TESCES5S(finish) EURO ESCUTCHEON 5MM SLIM SQUARE



SC



Finishes: MB, PC, PL, SC, RB, TT, WH  
 Base Material: Solid Brass  
 Sold only with bolt through fixings.  
 Can be fitted to all Atlantic locks only when using screws.  
 Screws not supplied with escutcheon.  
 Compatible with Atlantic Euro Mortice locks, DIN locks and magnetic locks.  
 Dimensions: Width/Height: 52mm Depth: 5mm  
 Unit: Sold in Pairs

## TWCR5S(finish) WC TURN & RELEASE 5MM SLIM ROUND



SC



Finishes: MB, PC, PL, SC, RB, TT, WH  
 Base Material: Solid Brass  
 Sold only with bolt through fixings.  
 Can be fitted to all Atlantic locks only when using screws.  
 Screws not supplied with WC Turn & Releases.  
 Also compatible with DIN locks and magnetic locks.  
 Dimensions: Rose Width/Height: 52mm Rose Depth: 5mm  
 Projection: 26mm

## TWCS5S(finish) WC TURN & RELEASE 5MM SLIM SQUARE



SC



Finishes: MB, PC, PL, SC, RB, TT, WH  
 Base Material: Solid Brass  
 Sold only with bolt through fixings.  
 Can be fitted to all Atlantic locks only when using screws.  
 Screws not supplied with WC Turn & Releases.  
 Also compatible with DIN locks and magnetic locks.  
 Dimensions: Rose Width/Height: 52mm Rose Depth: 5mm  
 Projection: 25mm



# retaline

# TUPAI®

Retaline showcases a bespoke rectangular feature rose that has a rich designer look and feel.

Slimline, refined and sophisticated. This feature rose makes a real design statement.

The range features a selection of modern finishes, from stunning & stylish satin chrome to the warm hues of pearl nickel.

With Retaline, the rose can be flipped and fitted vertically to create a stunning design feature.

RETALINE PANELA LEVER - PEARL BLACK



RETALINE / VERSALINE  
LONG ROSE WC  
TURN & RELEASE -  
PEARL BLACK



CURVA / QUADRALINE  
SQUARE ROSE EURO  
ESCUTCHEON - PEARL  
BLACK



# RILLO

*Designer Lever Door Handle*

LEVER ON ROSE - RECTANGULAR ROSE



Titanium (TT)

**T2275L(finish) RILLO LEVER ON RECTANGULAR ROSE**  
A contemporary lever on a unique rectangular rose.

Finishes: MB, PL, SC, TT  
Matching WC Turn: TWCL(finish)  
Matching Key Esc: TESCKL(finish)  
Euro Esc to suit: TESCES(finish)  
Matching Latch: AL3(finish)

Base Material: Zamak  
Dimensions:  
A: 52mm B: 130mm C: 11mm D: 57mm  
Rose Height: 35mm

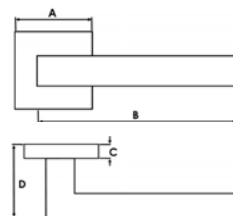

## FINISHES:



PEARL BLACK (MB)



PEARL NICKEL (PL)



SATIN CHROME (SC)



TITANIUM (TT)





# PANELA

*Designer Lever Door Handle*

LEVER ON ROSE - RECTANGULAR ROSE



Pearl Black (MB)

**T3099L(finish) PANELA** LEVER ON RECTANGULAR ROSE  
A statement lever with a modern rectangular rose.

Finishes: MB, PL, SC, TT  
Matching WC Turn: TWCL(finish)  
Matching Key Esc: TESCKL(finish)  
Euro Esc to suit: TESCES(finish)  
Matching Latch: AL3(finish)

Base Material: Zamak  
Dimensions:  
A: 52mm B: 154mm C: 11mm D: 52mm  
Rose Height: 35mm

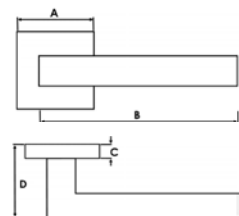

## FINISHES:



PEARL BLACK (MB)



PEARL NICKEL (PL)



SATIN CHROME (SC)



TITANIUM (TT)



# CARTELLE

*Designer Lever Door Handle*

LEVER ON ROSE - RECTANGULAR ROSE



Pearl Black (MB)

## T4084L(finish) CARTELLE LEVER ON RECTANGULAR ROSE

A bold rectangular lever with modern, straight edges.

Finishes: MB, SC  
Matching WC Turn: TWCL(finish)  
Matching Key Esc: TESCKL(finish)  
Euro Esc to suit: TESCES(finish)  
Matching Latch: AL3(finish)

Base Material: Zamak  
Dimensions:  
A: 52mm B: 161mm C: 11mm D: 55mm  
Rose Height: 35mm

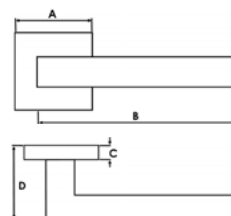

## FINISHES:



PEARL BLACK (MB)



SATIN CHROME (SC)

# SABROSA

*Designer Lever Door Handle*

LEVER ON ROSE - RECTANGULAR ROSE



Satin Chrome (SC)

## T3094LSC SABROSA LEVER ON RECTANGULAR ROSE

A statement lever with a stunning curved look.

Finishes: SC  
Matching WC Turn: TWCLSC  
Matching Key Esc: TESCKLSC  
Euro Esc to suit: TESCESSC  
Matching Latch: AL3SC

Base Material: Zamak  
Dimensions:  
A: 52mm B: 180mm C: 11mm D: 58mm  
Rose Height: 35mm

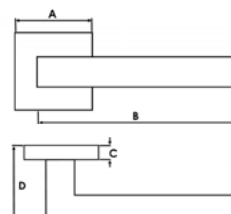



# TAVIRA

*Designer Lever Door Handle*

LEVER ON ROSE - RECTANGULAR ROSE

**TUPAI**



Titanium (TT)

**T3098L(finish) TAVIRA LEVER ON RECTANGULAR ROSE**  
A sleek and minimalistic lever, perfect for contemporary interiors.

Finishes: SC, TT  
Matching WC Turn: TWCL(finish)  
Matching Key Esc: TESCKL(finish)  
Euro Esc to suit: TESCES(finish)  
Matching Latch: AL3(finish)

Base Material: Zamak  
Dimensions:  
A: 52mm B: 134.5mm C: 11mm D: 72.4mm  
Rose Height: 35mm

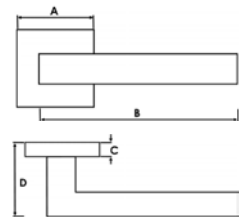

## FINISHES:



SATIN CHROME (SC)



TITANIUM (TT)



**VERSALINE**

**TUPAI®**

Customisable levers; choose from a variety of lever finishes alongside matching and contrasting decorative plates.

With a rectangular feature rose, Tobar is a truly versatile designer handle with both the lever finish and decorative plate adaptable to your taste. Choose your desired lever finish and then select a finish for the decorative plate. Alternatively, purchase without a decorative plate and style to suit your home interiors with an inlay of your favourite fabric or matching aesthetic. Get in touch for more customised made-to-order options.

**TUPAI**



# ACCESSORIES



MB

## TESCKL(finish) KEY ESCUTCHEON RECTANGULAR

Finishes Available: MB, PC, PL, SC, TT  
Base Material: Zamak

Sold with matching wood screws and bolt through fixings.  
Not compatible with any Atlantic locks.

Dimensions: Width: 52mm  
Height: 35mm Depth: 11mm  
Unit: Sold in Pairs



MB

## TWCL(finish) WC TURN & RELEASE RECTANGULAR

Finishes Available: MB, PC, PL, SC, TT  
Base Material: Zamak

Sold with matching wood screws.  
This product requires a bolt through fixing method, therefore must be fitted with ADBCE or ASDB Deadbolts, AGB magnetic locks, or DIN locks.

Dimensions: Rose Width: 52mm  
Rose Height: 35mm Rose Depth: 11mm  
Projection: 23mm



MB

## TESCES(finish) EURO ESCUTCHEON SQUARE

Finishes Available: MB, PC, PL, SC, TT  
Base Material: Zamak

Sold with matching wood screws and bolt through fixings.  
Compatible with Atlantic Euro Mortice locks.

Dimensions: Width/Height: 52mm  
Depth: 11mm  
Unit: Sold in Pairs

# TOBAR

## Designer Lever Door Handle

LEVER ON ROSE - RECTANGULAR ROSE



Satin Chrome (SC)

**T3089L(plate finish)(lever finish) TOBAR** LEVER ON RECTANGULAR ROSE  
A bold, statement lever with versatile decorative plate.

Lever Finishes: MB, PL, SC, TT  
Decorative Plate Finishes: MB, SSS, PSS, WH  
Matching WC Turn: TWCL(finish)  
Matching Key Esc: TESCKL(finish)  
Euro Esc to suit: TESCES(finish)

Matching Latch: AL3(finish)  
Base Material: Zamak  
Dimensions:  
A: 52mm B: 154mm C: 110mm D: 52mm  
Rose Height: 35mm

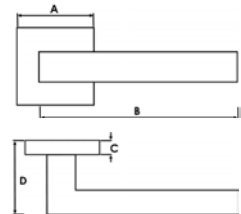

## FINISHES:



PEARL BLACK (MB)

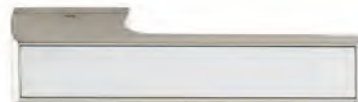

PEARL NICKEL (PL)



SATIN CHROME (SC)



TITANIUM (TT)

## DECORATIVE PLATES TO FIT TOBAR



BLACK DECORATIVE PLATE  
TITANIUM LEVER  
(T3089LMBTT)



SATIN STAINLESS STEEL  
DECORATIVE PLATE  
POLISHED NICKEL LEVER  
(T3089LSSSPL)



WHITE DECORATIVE PLATE  
SATIN CHROME LEVER  
(T3089LWHSC)



POLISHED STAINLESS STEEL  
DECORATIVE PLATE  
SATIN CHROME LEVER  
(T3089LPSSSL)

TUPAI

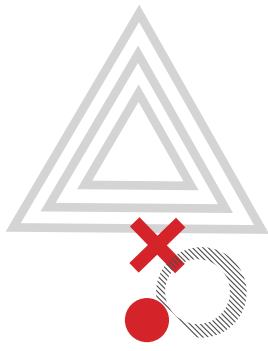

# quadraLINE

Quadraline boasts beautiful streamlined style and straight lines, creating stunning considered designs. This range is perfect for modern and minimal interior styles.

Quadraline's Rillo is sleek and minimalistic, perfect for functional contemporary living.

TUPAI

## RILLO

*Designer Lever Door Handle*

LEVER ON SLIM ROSE - SQUARE ROSE | LEVER ON CONCEALED ROSE



Pearl Black (MB)

### T2275S(finish) RILLO LEVER ON SQUARE ROSE

A sleek, modern and minimalistic lever.

Finishes: MB, SC

Matching WC Turn: TWCS(finish)

Matching Key Esc: TESCKS(finish)

Matching Key Esc: TESCES(finish)

Matching Latch: AL3(finish)

Base Material: Zamak

Dimensions:

A: 52mm B: 130mm C: 11mm D: 57mm

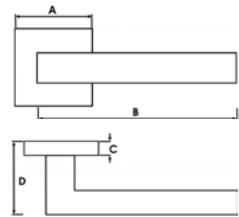

### T2275CS(finish) RILLO LEVER ON CONCEALED SQUARE ROSE

Finishes: MB, PC, PL, SC, TT

Matching WC Turn: FCSWC(finish)

Matching Key Esc: FCSK(finish)

Matching Euro Esc: FCSE(finish)

Note: Concealed rose levers can only be used with AGB magnetic locks.

## FINISHES:



PEARL BLACK (MB)



SATIN CHROME (SC)



BRIGHT POLISHED CHROME (PC)



PEARL NICKEL (PL)



TITANIUM (TT)



**TUPAI**

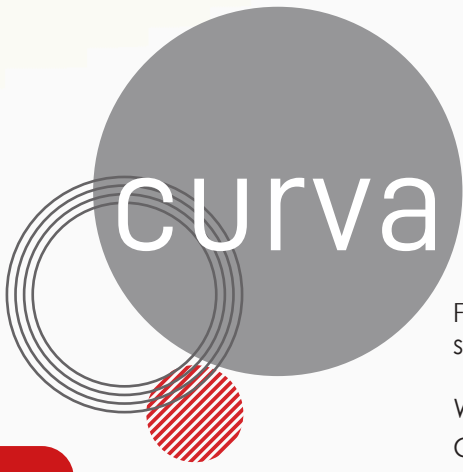

# curva line

Featuring classic and bold contemporary designs. Curvaline showcases a selection of refined curved levers that are design-led and timeless.

With a versatile range of finishes from sleek Matt Black and classic Satin Chrome, to luxe Titanium and warm Pearl Nickel.

**TUPAI**



● TUPAI TURIS LEVER - TITANIUM



# ADRA

## Designer Lever Door Handle

LEVER ON ROSE - ROUND ROSE | LEVER ON CONCEALED ROSE



Pearl Black (MB)

### T293R(finish) ADRA LEVER ON ROUND ROSE

A classic look with an updated modern feel.

Finishes: MB, PL, SC, TT  
 Matching WC Turn: TWCR(finish)  
 Matching Key Esc: TESCKR(finish)  
 Matching Euro Esc: TESKER(finish)  
 Matching Latch: AL3(finish)

Base Material: Zamak  
 Dimensions:  
 A: 52mm B: 135mm C: 11mm D: 65mm

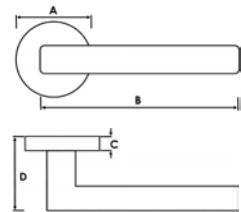

### T293CR(finish) ADRA LEVER ON CONCEALED ROUND ROSE

Finishes: MB, PL, SC, TT  
 Matching WC Turn: FCRWC(finish)  
 Matching Key Esc: FCRK(finish)

Matching Euro Esc: FCRE(finish)  
 Note: Concealed rose levers can only be used with AGB magnetic locks.

## FINISHES:



PEARL BLACK (MB)



PEARL NICKEL (PL)



SATIN CHROME (SC)



TITANIUM (TT)

# TURIS

*Designer Lever Door Handle*

LEVER ON ROSE - SQUARE ROSE



Pearl Black (MB)

## T2732S(finish) TURIS LEVER ON SQUARE ROSE

With sleek, curved details, Turis has an elevated modern feel.

Finishes: MB, SC, TT  
Matching WC Turn: TWCS(finish)  
Matching Key Esc: TESCKS(finish)  
Matching Euro Esc: TESCES(finish)

Matching Latch: AL3(finish)  
Base Material: Zamak  
Dimensions:  
A: 52mm B: 136mm C: 11mm D: 56mm

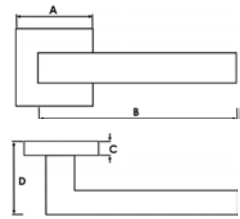

## FINISHES:



PEARL BLACK (MB)



SATIN CHROME (SC)



TITANIUM (TT)

# VALBONA

*Designer Lever Door Handle*

LEVER ON ROSE - SQUARE ROSE



Pearl Nickel (PL)

## T3097S(finish) VALBONA LEVER ON SQUARE ROSE

Valbona showcases stunning curved lines for a refined, contemporary look.

Finishes: PL, SC  
Matching WC Turn: TWCS(finish)  
Matching Key Esc: TESCKS(finish)  
Matching Euro Esc: TESCES(finish)

Matching Latch: AL3(finish)  
Base Material: Zamak  
Dimensions:  
A: 52mm B: 138mm C: 11mm D: 60mm

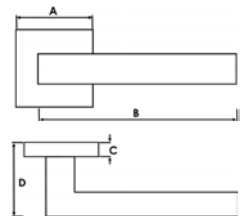

## FINISHES:



PEARL NICKEL (PL)



SATIN CHROME (SC)

# ACCESSORIES

ESCUTCHEONS - ROUND & SQUARE ROSE | WC TURN & RELEASE - ROUND & SQUARE ROSE



## TESCKR(finish) KEY ESCUTCHEON ROUND

Finishes: MB, PC, PL, SC, TT

Base Material: Zamak

Sold only with bolt through fixings.

Can be fitted to all Atlantic locks only when using screws.

Screws not supplied with escutcheon

Dimensions: Width/Height: 52mm Depth: 11mm

Unit: Sold in Pairs

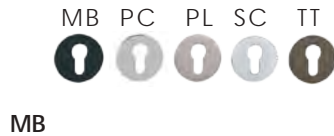

## TESCER(finish) EURO ESCUTCHEON ROUND

Finishes: MB, PC, PL, SC, TT

Base Material: Zamak

Sold only with bolt through fixings.

Can be fitted to all Atlantic locks only when using screws.

Screws not supplied with escutcheon.

Compatible with Atlantic Euro Mortice locks, DIN Locks

and magnetic locks.

Dimensions: Width/Height: 52mm Depth: 11mm

Unit: Sold in Pairs



## TESCKS(finish) KEY ESCUTCHEON SQUARE

Finishes: MB, PC, PL, SC, TT

Base Material: Zamak

Sold only with bolt through fixings.

Can be fitted to all Atlantic locks only when using screws.

Screws not supplied with escutcheon.

Dimensions: Width/Height: 52mm Depth: 11mm

Unit: Sold in Pairs



## TESCES(finish) EURO ESCUTCHEON SQUARE

Finishes: MB, PC, PL, SC, TT

Base Material: Zamak

Sold only with bolt through fixings.

Can be fitted to all Atlantic locks only when using screws.

Screws not supplied with escutcheon.

Compatible with Atlantic Euro Mortice locks, DIN Locks

and magnetic locks.

Dimensions: Width/Height: 52mm Depth: 11mm

Unit: Sold in Pairs



## TWCR(finish) WC TURN & RELEASE ROUND

Finishes: MB, PC, PL, SC, TT

Base Material: Zamak

Sold with matching wood screws.

Bolt through fixing method therefore

This product requires a bolt through fixing method,

therefore must be fitted with ADBCE or ASDB Deadbolts,

AGB magnetic locks, or DIN locks.

Dimensions: Rose Width/Height: 52mm Rose Depth: 11mm

Projection: 23mm



## TWCS(finish) WC TURN & RELEASE SQUARE

Finishes: MB, PC, PL, SC, TT

Base Material: Zamak

Sold with matching wood screws.

This product requires a bolt through fixing method,

therefore must be fitted with ADBCE or ASDB Deadbolts,

AGB magnetic locks, or DIN locks.

Dimensions: Rose Width/Height: 52mm Rose Depth: 11mm

Projection: 23mm



TUPAI



○ — ● FORME ALILA LEVER - MATT BLACK



● — ○ FORME SQUARE ROSE  
EURO ESCUTCHEON -  
MATT BLACK

# forme

Made in Italy, our designer Forme range features the highest level of craftsmanship that only a company with over 65 years manufacturing experience can guarantee.

Defined by its contemporary and timeless designs, this stunning range of handles has over 15 designs in 13 exclusive finishes, all available from stock. Made unique by the ground-breaking "Fixa" fast fit rose system, this range has become a favourite with quality housing developers, architects and interior designers across the country.

From the understated elegance of the Polished Nickel finish to the bold urban finish of Matt Black, this collection of distinctive door levers is anything but typical. The strong and bold durable finishes enhance the tactile styles, making a design statement that elevates and entices.

Find out how to fit  
a Fixa Lever:



FORME SQUARE ROSE WC TURN  
& RELEASE - MATT BLACK

# forme

Our Forme levers are among the most environmentally friendly designer lever collections, thanks to their innovative manufacturing process. Forme's product finish process, named Ecotech, is entirely based around Nanotechnology.

#### ***What are the benefits?***

- Cleaner technology
- Process is less harmful to the environment & people involved in the production process
- High resistance to abrasion
- Uniform coating with the possibilities of achieving innovative colours
- Unbreakable bond between finish and metal (Zamak & Brass)

Find out more  
about Ecotech:



FORME SQUARE ROSE WC TURN  
& RELEASE - MATT BLACK



All of our Forme products in the Matt Black finish are now coated with our CleanTouch antibacterial protection.

**What does this mean?**

99% cleaner than unprotected surfaces, CleanTouch offers a hospital-level of hygiene in trending designs.

Scientifically proven, the treatment used to coat these products ensures total elimination of bacteria.

Using a non-toxic finishing treatment (unlike other anti-bacterial powder varnishes) it creates a safer space for people to live and work in.



FORME GINEVRA  
LEVER - MATT BLACK



FORME SQUARE ROSE  
EURO ESCUTCHEON -  
MATT BLACK





# MILLY

*Designer Lever Door Handle*

LEVER ON ROSE - ROUND ROSE | LEVER ON CONCEALED ROSE



Urban Graphite (UG)

**FMR133(finish) MILLY LEVER ON ROUND ROSE**

An understated, minimal design in a range of stunning finishes.

Finishes: MB, PC, SC, SN, UB, UG, USC  
 Matching WC Turn: FMRWC(finish)  
 Matching Key Esc: FMRK(finish)  
 Matching Euro Esc: FMRE(finish)  
 Matching Latch: AL3(finish)

Base Material: Zamak  
 Dimensions:  
 A: 50mm B: 128mm C: 10mm D: 63mm

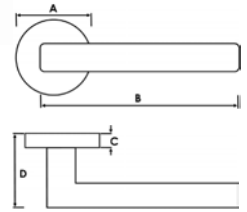

**FCR133(finish) MILLY LEVER ON CONCEALED ROUND ROSE**

Finishes: MB, PC, SC, SN, UB  
 Matching WC Turn: FCRWC(finish)  
 Matching Key Esc: FCRK(finish)

Matching Euro Esc: FCRE(finish)  
 Note: Concealed rose levers can only be used with AGB magnetic locks.

## FINISHES:



MATT BLACK (MB)



POLISHED CHROME (PC)



SATIN CHROME (SC)



SATIN NICKEL (SN)



URBAN BRONZE (UB)



URBAN GRAPHITE (UG)



SATIN CHROME POLISHED CHROME (SCPC) FMR158SCPC



URBAN SATIN CHROME (USC)





# ELLE

*Designer Lever Door Handle*

LEVER ON ROSE - ROUND ROSE | LEVER ON CONCEALED ROSE



Matt Black (MB)

## FMR236(finish) ELLE LEVER ON ROUND ROSE

A classic lever with a modern designer look.

Finishes: MB, PC, SC, SN, UDB  
 Matching WC Turn: FMRWC(finish)  
 Matching Key Esc: FMRK(finish)  
 Matching Euro Esc: FMRE(finish)  
 Matching Latch: AL3(finish)

Base Material: Zamak  
 Dimensions:  
 A: 50mm B: 127mm C: 10mm D: 68mm

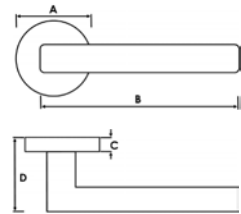

## FCR236(finish) ELLE LEVER ON ROUND ROSE

Finishes: MB, PC, SC, SN, UDB  
 Matching WC Turn: FCRWC(finish)  
 Matching Key Esc: FCRK(finish)

Matching Euro Esc: FCRE(finish)  
 Note: Concealed rose levers can only be used with AGB magnetic locks.

## FINISHES:



MATT BLACK (MB)



POLISHED CHROME (PC)



SATIN CHROME (SC)



SATIN NICKEL (SN)



URBAN DARK BRONZE (UDB)



# ASTI

## Designer Lever Door Handle

LEVER ON ROSE - ROUND ROSE



Satin Nickel (SN)

### FMR254(finish) ASTI LEVER ON ROUND ROSE

A sleek and stylish designer lever with a choice of round, square and concealed rose.

Finishes: MB, PC, SC, SN, UB, UG, YB, SCPC  
 Matching WC Turn: FMRWC(finish)  
 Matching Key Esc: FMRK(finish)  
 Matching Euro Esc: FMRE(finish)  
 Matching Latch: AL3(finish)

Base Material: Zamak  
 Dimensions:  
 A: 50mm B: 129mm C: 10mm D: 56mm

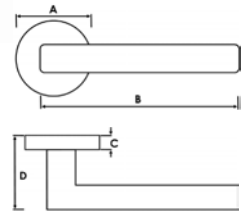

## FINISHES:



MATT BLACK (MB)



POLISHED CHROME (PC)



SATIN CHROME (SC)



SATIN NICKEL (SN)



URBAN BRONZE (UB)



URBAN GRAPHITE (UG)



YESTER BRONZE (YB)



SATIN CHROME POLISHED CHROME (SCPC) FMR255SCPC

# ASTI

## Designer Lever Door Handle

LEVER ON ROSE - SQUARE ROSE | LEVER ON CONCEALED ROSE



Matt Black (MB)

### FMS254(finish) ASTI LEVER ON SQUARE ROSE

A sleek and stylish designer lever with a choice of round, square and concealed rose.

Finishes: MB, PC, SC, SN, UB, UDB, UG, YB  
 Matching WC Turn: FMSWC(finish)  
 Matching Key Esc: FMSK(finish)  
 Matching Euro Esc: FMSE(finish)

Matching Latch: AL3(finish)  
 Base Material: Zamak  
 Dimensions:  
 A: 50mm B: 129mm C: 10mm D: 56mm

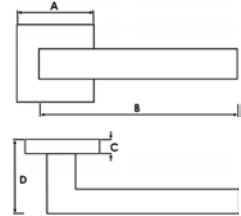

### FCS254(finish) ASTI LEVER ON CONCEALED SQUARE ROSE

Finishes: MB, PC, SC, SN, UB, UDB, YB  
 Matching WC Turn: FCSWC(finish)  
 Matching Key Esc: FCSK(finish)

Matching Euro Esc: FCSE(finish)  
 Note: Concealed rose levers can only be used with AGB magnetic locks

## FINISHES:



MATT BLACK (MB)



POLISHED CHROME (PC)



SATIN CHROME (SC)



SATIN NICKEL (SN)



URBAN BRONZE (UB)



URBAN DARK BRONZE (UDB)



URBAN GRAPHITE (UG)



YESTER BRONZE (YB)

# FOGLIA

## Designer Lever Door Handle

LEVER ON ROSE - ROUND & SQUARE ROSE | LEVER ON CONCEALED ROSE



Satin Chrome (SC)

### FMR272(finish) FOGLIA LEVER ON ROUND ROSE

Foglia combines angular design details with softer curved lines.

Finishes: MB, PC, SC  
 Matching WC Turn: FMRWC(finish)  
 Matching Key Esc: FMRK(finish)  
 Matching Euro Esc: FMRE(finish)

Matching Latch: AL3(finish)  
 Base Material: Zamak  
 Dimensions:  
 A: 50mm B: 134mm C: 10mm D: 70mm

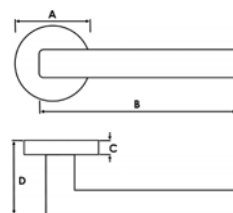

### FCR272(finish) FOGLIA LEVER ON CONCEALED ROUND ROSE

Finishes: MB, SC  
 Matching WC Turn: FCRWC(finish)  
 Matching Key Esc: FCRK(finish)

Matching Euro Esc: FCRE(finish)  
 Note: Concealed rose levers can only be used with AGB magnetic locks

## FINISHES:



MATT BLACK (MB)



POLISHED CHROME (PC)



SATIN CHROME (SC)



Polished Chrome (PC)

### FMS272(finish) FOGLIA LEVER ON SQUARE ROSE

Foglia combines angular design details with softer curved lines.

Finishes: MB, SC  
 Matching WC Turn: FMSWC(finish)  
 Matching Key Esc: FMSK(finish)  
 Matching Euro Esc: FMSE(finish)

Matching Latch: AL3(finish)  
 Base Material: Zamak  
 Dimensions:  
 A: 50mm B: 134mm C: 10mm D: 70mm

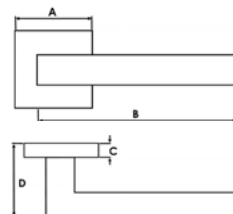

## FINISHES:



MATT BLACK (MB)



SATIN CHROME (SC)

# BOSTON

## Designer Lever Door Handle

LEVER ON ROSE - ROUND & SQUARE ROSE | LEVER ON CONCEALED ROSE



Urban Graphite (UG)

### FMR422(finish) BOSTON LEVER ON ROUND ROSE

A contemporary, streamlined look with a choice of round, square or concealed rose.

Finishes: MB, PC, UG

Matching WC Turn: FMRWC(finish)

Matching Key Esc: FMRK(finish)

Matching Euro Esc: FMRE(finish)

Matching Latch: AL3(finish)

Base Material: Zamak

Dimensions:

A: 50mm B: 140mm C: 10mm D: 66mm

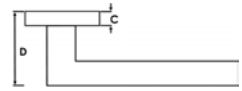
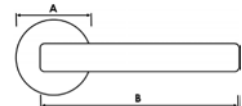

### FCR422(finish) BOSTON LEVER ON CONCEALED ROUND ROSE

Finishes: MB, PC

Matching WC Turn: FCRWC(finish)

Matching Key Esc: FCRK(finish)

Matching Euro Esc: FCRE(finish)

Note: Concealed rose levers can only be used with AGB magnetic locks

## FINISHES:



MATT BLACK (MB)



POLISHED CHROME (PC)



URBAN GRAPHITE (UG)



Matt Black (MB)

### FMS422(finish) BOSTON LEVER ON SQUARE ROSE

A contemporary, streamlined look with a choice of round, square or concealed rose.

Finishes: MB, PC, SC, UG

Matching WC Turn: FMSWC(finish)

Matching Key Esc: FMSK(finish)

Matching Euro Esc: FMSE(finish)

Matching Latch: AL3(finish)

Base Material: Zamak

Dimensions:

A: 50mm B: 140mm C: 10mm D: 66mm

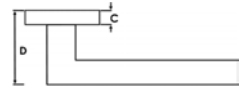
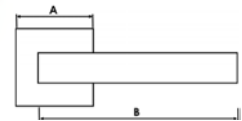

## FINISHES:



MATT BLACK (MB)



POLISHED CHROME (PC)



SATIN CHROME (SC)



URBAN GRAPHITE (UG)

# GINEVRA

## Designer Lever Door Handle

LEVER ON ROSE - ROUND & SQUARE ROSE | LEVER ON CONCEALED ROSE



Matt Black (MB)

### FMR430(finish) GINEVRA LEVER ON ROUND ROSE

A unique lever with bold design details.

Finishes: MB, SC  
 Matching WC Turn: FMRWC(finish)  
 Matching Key Esc: FMRK(finish)  
 Matching Euro Esc: FMRE(finish)

Matching Latch: AL3(finish)  
 Base Material: Zamak  
 Dimensions:  
 A: 50mm B: 138mm C: 10mm D: 74mm

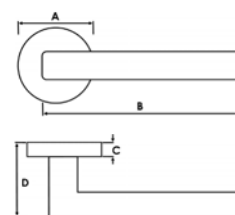

## FINISHES:



MATT BLACK (MB)



SATIN CHROME (SC)



Satin Chrome (SC)

### FMS430(finish) GINEVRA LEVER ON SQUARE ROSE

A unique lever with bold design details.

Finishes: MB, SC  
 Matching WC Turn: FMSWC(finish)  
 Matching Key Esc: FMSK(finish)  
 Matching Euro Esc: FMSE(finish)

Matching Latch: AL3(finish)  
 Base Material: Zamak  
 Dimensions:  
 A: 50mm B: 138mm C: 10mm D: 74mm

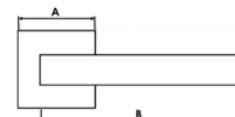

### FCS430(finish) GINEVRA LEVER ON CONCEALED SQUARE ROSE

Finishes: MB, SC  
 Matching WC Turn: FCSWC(finish)  
 Matching Key Esc: FCSK(finish)

Matching Euro Esc: FCSE(finish)  
 Note: Concealed rose levers can only be used with AGB magnetic locks

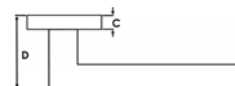

## FINISHES:



MATT BLACK (MB)



SATIN CHROME (SC)



● FORME GINEVRA -  
SATIN CHROME

# CRYSTAL

## Designer Lever Door Handle

LEVER ON ROSE - ROUND & SQUARE ROSE | LEVER ON CONCEALED ROSE



Yester Bronze (YB)

### FMR268(finish) CRYSTAL LEVER ON ROUND ROSE

A bold, angular design, available on round, square and concealed roses.

Finishes: SC, YB

Matching WC Turn: FMRWC(finish)

Matching Key Esc: FMRK(finish)

Matching Euro Esc: FMRE(finish)

Matching Latch: AL3(finish)

Base Material: Zamak

Dimensions:

A: 50mm B: 138mm C: 10mm D: 60mm

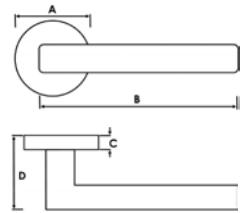

## FINISHES:



SATIN CHROME (SC)



YESTER BRONZE (YB)



Polished Chrome (PC)

### FMS268(finish) CRYSTAL LEVER ON SQUARE ROSE

A bold, angular design, available on round, square and concealed roses.

Finishes: PC, SC, YB

Matching WC Turn: FMSWC(finish)

Matching Key Esc: FMSK(finish)

Matching Euro Esc: FMSE(finish)

Matching Latch: AL3(finish)

Base Material: Zamak

Dimensions:

A: 50mm B: 138mm C: 10mm D: 60mm

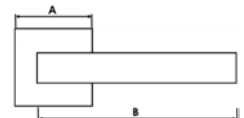

### FCS268(finish) CRYSTAL LEVER ON CONCEALED SQUARE ROSE

Finishes: PC, SC, YB

Matching WC Turn: FCSWC(finish)

Matching Key Esc: FCSK(finish)

Matching Euro Esc: FCSE(finish)

Note: Concealed rose levers can only be used with AGB magnetic locks

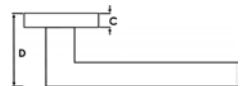

## FINISHES:



POLISHED CHROME (PC)



SATIN CHROME (SC)



YESTER BRONZE (YB)





# NAXOS

*Designer Lever Door Handle*

LEVER ON ROSE - SQUARE ROSE | LEVER ON CONCEALED ROSE



Polished Chrome (PC)

## FMS215(finish) NAXOS LEVER ON SQUARE ROSE

A striking lever with a bold architectural feel.

Finishes: MB, PC, SC, UG  
 Matching WC Turn: FMSWC(finish)  
 Matching Key Esc: FMSK(finish)  
 Matching Euro Esc: FMSE(finish)  
 Matching Latch: AL3(finish)

Base Material: Zamak  
 Dimensions:  
 A: 50mm B: 140mm C: 10mm D: 63mm

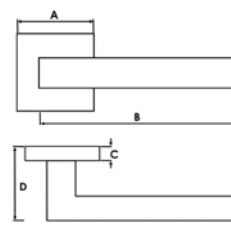

## FCS215(finish) NAXOS LEVER ON CONCEALED SQUARE ROSE

Finishes: MB, PC, SC  
 Matching WC Turn: FCSWC(finish)  
 Matching Key Esc: FCSK(finish)

Matching Euro Esc: FCSE(finish)  
 Note: Concealed rose levers can only be used with AGB magnetic locks.

## FINISHES:



MATT BLACK (MB)



POLISHED CHROME (PC)



SATIN CHROME (SC)



URBAN GRAPHITE (UG)



# ALILA

## Designer Lever Door Handle

LEVER ON ROSE - SQUARE ROSE | LEVER ON CONCEALED ROSE



Polished Nickel (PN)

### FMS293(finish) ALILA LEVER ON SQUARE ROSE

Art Deco inspired Alila is rich in design character.

Finishes: MB, PN, SN, UDB  
 Matching WC Turn: FMSWC(finish)  
 Matching Key Esc: FMSK(finish)  
 Matching Euro Esc: FMSE(finish)  
 Matching Latch: AL3(finish)

Base Material: Zamak  
 Dimensions:  
 A: 50mm B: 128mm C: 10mm D: 57mm

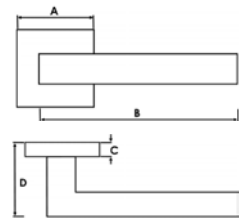

### FCS293(finish) ALILA LEVER ON CONCEALED SQUARE ROSE

Finishes: MB, PN, SN, UDB  
 Matching WC Turn: FCSWC(finish)  
 Matching Key Esc: FCSK(finish)

Matching Euro Esc: FCSE(finish)  
 Note: Concealed rose levers can only be used with AGB magnetic locks.

## FINISHES:



MATT BLACK (MB)



POLISHED NICKEL (PN)



SATIN NICKEL (SN)



URBAN DARK BRONZE (UDB)

# OLIMPIA

## Designer Lever Door Handle

LEVER ON ROSE - ROUND & SQUARE ROSE | LEVER ON CONCEALED ROSE



Satin Chrome (SC)

### FMR280(finish) OLIMPIA LEVER ON ROUND ROSE

Stunning curved lines with a statement designer feel.

Finishes: PC, SC

Matching WC Turn: FMRWC(finish)

Matching Key Esc: FMRK(finish)

Matching Euro Esc: FMRE(finish)

Matching Latch: AL3(finish)

Base Material: Zamak

Dimensions:

A: 50mm B: 128mm C: 10mm D: 63mm

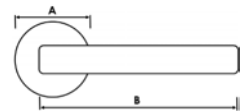

### FCR280SC OLIMPIA LEVER ON CONCEALED ROUND ROSE

Finishes: SC

Matching WC Turn: FCRWCSC

Matching Key Esc: FCRKSC

Matching Euro Esc: FCRESC

Note: Concealed rose levers can only be used with AGB magnetic locks.

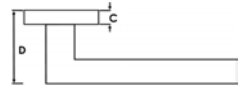

## FINISHES:



POLISHED CHROME (PC)



SATIN CHROME (SC)



Satin Chrome (SC)

### FMS280(finish) OLIMPIA LEVER ON SQUARE ROSE

Stunning curved lines with a statement designer feel.

Finishes: PC, SC

Matching WC Turn: FMSWC(finish)

Matching Key Esc: FMSK(finish)

Matching Euro Esc: FMSE(finish)

Matching Latch: AL3(finish)

Base Material: Zamak

Dimensions:

A: 50mm B: 136mm C: 10mm D: 64mm

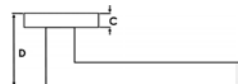

## FINISHES:



POLISHED CHROME (PC)



SATIN CHROME (SC)

# MONZA

## Designer Lever Door Handle

LEVER ON ROSE - ROUND ROSE | LEVER ON CONCEALED ROSE



Polished Chrome (PC)

### FMR413PC MONZA LEVER ON ROUND ROSE PC

A unique and distinctive design with stunning curved details.

Finishes: PC  
 Matching WC Turn: FMRWCPC  
 Matching Key Esc: FMRKPC  
 Matching Euro Esc: FMREPC

Matching Latch: AL3PC  
 Base Material: Zamak  
 Dimensions:  
 A: 50mm B: 131mm C: 10mm D: 61mm

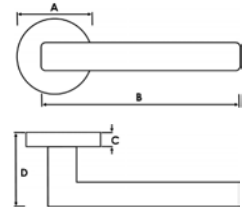

Satin Chrome (SC)

### FMS413SC MONZA LEVER ON SQUARE ROSE SC

A unique and distinctive design with stunning curved details.

Finishes: SC  
 Matching WC Turn: FMSWCSC  
 Matching Key Esc: FMSKSC  
 Matching Euro Esc: FMSESC

Matching Latch: AL3SC  
 Base Material: Zamak  
 Dimensions:  
 A: 50mm B: 131mm C: 10mm D: 61mm

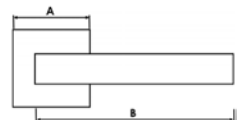

### FCS413SC MONZA LEVER ON CONCEALED SQUARE ROSE SC

Finishes: SC  
 Matching WC Turn: FCSWCSC  
 Matching Key Esc: FCSKSC

Matching Euro Esc: FCSESC  
 Note: Concealed rose levers can only be used with AGB magnetic locks

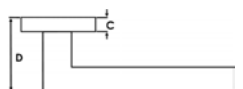

# ARTEMIDE

## *Designer Lever Door Handle*

LEVER ON ROSE - SQUARE ROSE | LEVER ON CONCEALED ROSE



Matt Black (MB)

### **FMS213MB ARTEMIDE LEVER ON SQUARE ROSE**

A statement lever with a contemporary curved look.

Finishes: MB  
Matching WC Turn: FMSWCMB  
Matching Key Esc: FMSKMB  
Matching Euro Esc: FMSEMB

Matching Latch: AL3MB  
Base Material: Zamak  
Dimensions:  
A: 50mm B: 138mm C: 10mm D: 63mm

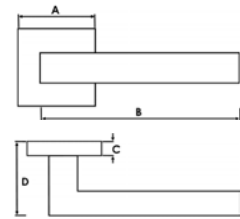

### **FCS213MB ARTEMIDE LEVER ON CONCEALED SQUARE ROSE**

Finishes: MB  
Matching WC Turn: FCSWCMB  
Matching Key Esc: FCSKMB

Matching Euro Esc: FCSE  
Note: Concealed rose levers can only be used with AGB magnetic locks

# LORENA

## *Designer Lever Door Handle*

LEVER ON ROSE - SQUARE ROSE



Urban Satin Chrome (USC)

### **FMS136USC LORENA LEVER ON SQUARE ROSE USC**

A bold statement lever in a unique Satin Chrome finish.

Finishes: USC  
Matching WC Turn: FMSWCUSC  
Matching Key Esc: FMSKUSC  
Matching Euro Esc: FMSEUSC

Matching Latch: AL3USC  
Base Material: Zamak  
Dimensions:  
A: 50mm B: 136mm C: 10mm D: 60mm

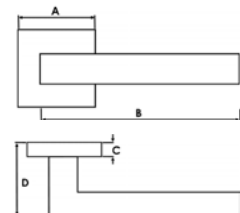

# ACCESSORIES

ESCUTCHEONS - ROUND & SQUARE ROSE | WC TURN & RELEASE - ROUND & SQUARE ROSE



UG

MB PC SC SN UB UDB UG USC YB



## FMRK(finish) KEY ESCUTCHEON ROUND

Finishes: MB, PC, SC, SN, UB, UDB, UG, USC, YB  
Base Material: Zamak  
Sold with matching wood screws.  
Dimensions: Width/Height: 50mm Depth: 10mm  
Unit: Sold in Pairs



UG

MB PC SC SN UB UDB UG USC YB



## FMRE(finish) EURO ESCUTCHEON ROUND

Finishes: MB, PC, SC, SN, UB, UDB, UG, USC, YB  
Base Material: Zamak  
Sold with matching wood screws.  
Dimensions: Width/Height: 50mm Depth: 10mm  
Unit: Sold in Pairs



UG

MB PC PN SC SN UB UDB UG USC YB



## FMSK(finish) KEY ESCUTCHEON SQUARE

Finishes: MB, PC, PN, SC, SN, UB, UDB, UG, USC, YB  
Base Material: Zamak  
Sold with matching wood screws.  
Dimensions: Width/Height: 50mm Depth: 10mm  
Unit: Sold in Pairs



UG

MB PC PN SC SN UB UDB UG USC YB



## FMSE(finish) EURO ESCUTCHEON SQUARE

Finishes: MB, PC, PN, SC, SN, UB, UDB, UG, USC, YB  
Base Material: Zamak  
Sold with matching wood screws.  
Dimensions: Width/Height: 50mm Depth: 10mm  
Unit: Sold in Pairs



UG

MB PC SC SN UB UDB UG USC YB



## FMRWC(finish) WC TURN & RELEASE ROUND

Finishes: MB, PC, SC, SN, UB, UDB, UG, USC, YB  
Base Material: Zamak  
Sold with matching wood screws.  
Dimensions: Rose Width/Height: 50mm Depth: 10mm  
Projection: 45mm



UG

MB PC PN SC SN UB UDB UG USC YB



## FMSWC(finish) WC TURN & RELEASE SQUARE

Finishes: MB, PC, PN, SC, SN, UB, UDB, UG, USC, YB  
Base Material: Zamak  
Sold with matching wood screws.  
Dimensions: Rose Width/Height: 50mm Depth: 10mm  
Projection: 45mm



MB

MB PC SC SN UDB WH



## FCRESCE(finish) CONCEALED EURO ESCUTCHEON ROUND

Finishes: MB, PC, SC, SN, UDB, WH  
Base Material: Zamak  
Dimensions: Width/Height: 25mm/40mm Depth: 7mm  
Unit: Sold in Pairs



MB

MB PC SC SN UDB YB



## FCSESCE(finish) CONCEALED EURO ESCUTCHEON SQUARE

Finishes: MB, PC, SC, SN, UDB, YB  
Base Material: Zamak  
Dimensions: Width/Height: 25mm/40mm Depth: 7mm  
Unit: Sold in Pairs



MB

MB PC SC SN UDB WH



## FCRWC(finish) CONCEALED WC TURN ROUND

Finishes: MB, PC, SC, SN, UDB, WH  
Base Material: Zamak  
Dimensions: Width/Height: 25mm Depth: 7mm  
Projection: 25mm



MB

MB PC SC SN UDB YB



## FCSWC(finish) CONCEALED WC TURN SQUARE

Finishes: MB, PC, SC, SN, UDB, YB  
Base Material: Zamak  
Dimensions: Width/Height: 25mm Depth: 7mm  
Projection: 25mm

● FORME GINEVRA -  
SATIN CHROME



ORO & ORO SKYWALKER  
LEVER - MATT BLACK



ORO & ORO SQUARE ROSE EURO  
ESCUTCHEON - MATT BLACK





# ORO & ORO

Showcasing dynamic design-led handles, our new Oro & Oro range is a celebration of Italian craftsmanship at its finest. The collection blends classic and contemporary styles, with each piece meticulously crafted to reflect the bold and artistic spirit of Italian design. From striking architectural and geometric designs, to sleek and streamlined contemporary handles, the collection features a full range of statement pieces.

The collection is available in two timeless and versatile finishes - Matt Black and Satin Chrome - ensuring that there's a product to suit every style and space.



ORO & ORO SQUARE ROSE WC  
TURN & RELEASE - MATT BLACK

# ORO & ORO

This premium Italian collection showcases 11 eye-catching lever designs, offering a variety of styles to suit any interior aesthetic. With 5 of these designs readily available from stock and an additional 6 available through special order, there's something to complement every space, whether you're after something classic or uniquely tailored.

Each design in this collection is available in two stunning and versatile finishes - Matt Black and Satin Chrome.

To complete the look, the range also features a full suite of matching accessories, including WC Turn & Releases and Euro & Key Escutcheons. These coordinated elements provide a cohesive and sophisticated door solution, allowing you to achieve a polished, unified design throughout your space. Whether you're outfitting a residential project or a commercial environment, this collection delivers exceptional style and quality, elevating every detail of your doors.

ORO & ORO SQUARE ROSE WC  
TURN & RELEASE - SATIN CHROME



ORO & ORO SIENNA  
LEVER - SATIN CHROME

ORO & ORO SQUARE ROSE EURO  
ESCUTCHEON - SATIN CHROME

# UNICA

*Designer Lever Door Handle*

LEVER ON ROSE - SQUARE ROSE



Matt Black (MB)

## **O6515E(finish) UNICA** LEVER ON SQUARE ROSE

A stunning and unique lever on minimal square rose.

Finishes: MB, SC  
Matching WC Turn: O31WC15E(finish)  
Matching Key Esc: O15EK(finish)  
Matching Euro Esc: O15EE(finish)

Matching Latch: AL3(finish)  
Base Material: Zinc Alloy  
Dimensions:  
A: 52mm B: 135mm C: 10mm D: 69mm

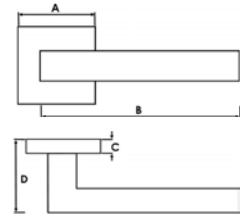

## FINISHES:



MATT BLACK (MB)



SATIN CHROME (SC)

# SKYWALKER

*Designer Lever Door Handle*

LEVER ON ROSE - SQUARE ROSE



Satin Chrome (SC)

## **O8015E(finish) SKYWALKER** LEVER ON SQUARE ROSE

A statement lever with a dynamic design on minimal square rose.

Finishes: MB, SC  
Matching WC Turn: O31WC15E(finish)  
Matching Key Esc: O15EK(finish)  
Matching Euro Esc: O15EE(finish)

Matching Latch: AL3(finish)  
Base Material: Zinc Alloy  
Dimensions:  
A: 52mm B: 151mm C: 10mm D: 66mm

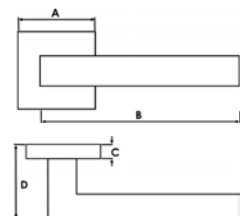

## FINISHES:



MATT BLACK (MB)



SATIN CHROME (SC)

# IVY

## Designer Lever Door Handle

LEVER ON ROSE - SQUARE ROSE



Satin Chrome (SC)

**O9615E(finish) IVY LEVER ON SQUARE ROSE**  
A chic statement lever on minimal square rose.

Finishes: MB, SC  
Matching WC Turn: O31WC15E(finish)  
Matching Key Esc: O15EK(finish)  
Matching Euro Esc: O15EE(finish)

Matching Latch: AL3(finish)  
Base Material: Zinc Alloy  
Dimensions:  
A: 52mm B: 135mm C: 10mm D: 58mm

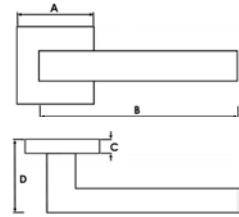

### FINISHES:



MATT BLACK (MB)



SATIN CHROME (SC)

# SIENNA

## Designer Lever Door Handle

LEVER ON ROSE - SQUARE ROSE



Matt Black (MB)

**O9215E(finish) SIENNA LEVER ON SQUARE ROSE**  
A contemporary lever with architectural design details.

Finishes: MB, SC  
Matching WC Turn: O31WC15E(finish)  
Matching Key Esc: O15EK(finish)  
Matching Euro Esc: O15EE(finish)

Matching Latch: AL3(finish)  
Base Material: Zinc Alloy  
Dimensions:  
A: 52mm B: 138mm C: 10mm D: 73mm

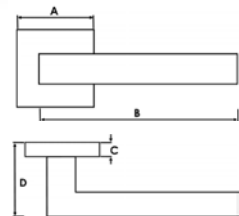

### FINISHES:



MATT BLACK (MB)



SATIN CHROME (SC)

# GALASSIA

*Designer Lever Door Handle*

LEVER ON ROSE - SQUARE ROSE



Satin Chrome (SC)

## **O10815E(finish) GALASSIA LEVER ON SQUARE ROSE**

A bold designer lever on minimal square rose.

Finishes: MB, SC  
Matching WC Turn: O31WC15E(finish)  
Matching Key Esc: O15EK(finish)  
Matching Euro Esc: O15EE(finish)

Matching Latch: AL3(finish)  
Base Material: Zinc Alloy  
Dimensions:  
A: 52mm B: 144mm C: 10mm D: 53mm

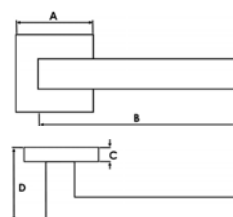

## FINISHES:



MATT BLACK (MB)



SATIN CHROME (SC)

# STRADI SPECIAL ORDER

*Designer Lever Door Handle*

LEVER ON ROSE - ROUND ROSE



Matt Black (MB)

## **O10917E(finish) STRADI LEVER ON ROUND ROSE**

A unique lever with stunning knurling details.

Finishes: MB, SC  
Matching WC Turn: O31WC15E(finish)  
Matching Key Esc: O15EK(finish)  
Matching Euro Esc: O15EE(finish)

Matching Latch: AL3(finish)  
Base Material: Zinc Alloy  
Dimensions:  
A: 56mm B: 147mm C: 12mm D: 62mm

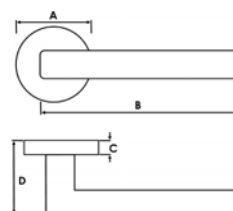

## FINISHES:



MATT BLACK (MB)



SATIN CHROME (SC)

# ALBA SPECIAL ORDER

*Designer Lever Door Handle*

LEVER ON ROSE - SQUARE ROSE

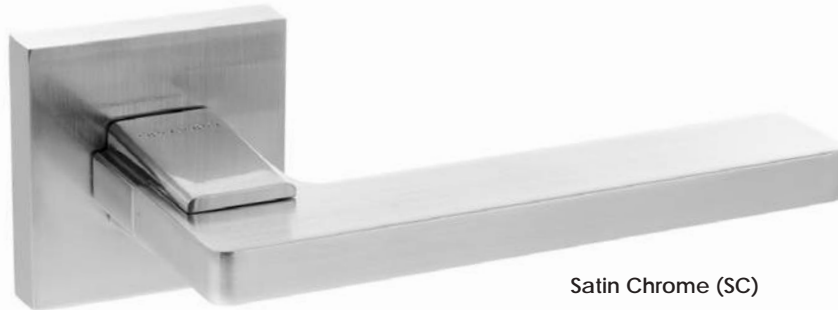

Satin Chrome (SC)

## O6815E(finish) ALBA LEVER ON SQUARE ROSE

A modern and sleek lever on a minimal square rose.

Finishes: MB, SC  
 Matching WC Turn: O31WC15E(finish)  
 Matching Key Esc: O15EK(finish)  
 Matching Euro Esc: O15EE(finish)

Matching Latch: AL3(finish)  
 Base Material: Zinc Alloy  
 Dimensions:  
 A: 52mm B: 128mm C: 10mm D: 68mm

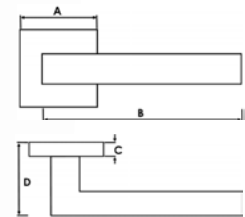

## FINISHES:



MATT BLACK (MB)



SATIN CHROME (SC)

# FRANA SPECIAL ORDER

*Designer Lever Door Handle*

LEVER ON ROSE - SQUARE ROSE



Matt Black (MB)

## O9315EMB FRANA LEVER ON SQUARE ROSE

A statement lever with unique form.

Finishes: MB  
 Matching WC Turn: O31WC15E(finish)  
 Matching Key Esc: O15EK(finish)  
 Matching Euro Esc: O15EE(finish)

Matching Latch: AL3(finish)  
 Base Material: Zinc Alloy  
 Dimensions:  
 A: 52mm B: 136mm C: 10mm D: 68mm

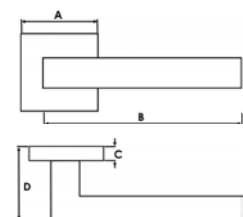

# ARIA SPECIAL ORDER

*Designer Lever Door Handle*

LEVER ON ROSE - SQUARE ROSE



Matt Black (MB)

## O10015EMB ARIA LEVER ON SQUARE ROSE

A stunning and unique twisted lever with stunning linear details.

Finishes: MB  
Matching WC Turn: O31WC15EMB  
Matching Key Esc: O15EKMB  
Matching Euro Esc: O15EEMB  
Matching Latch: AL3MB

Base Material: Zinc Alloy  
Dimensions:  
A: 52mm B: 149mm C: 10mm D: 63mm

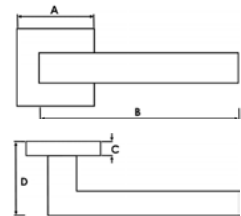

# OIA SPECIAL ORDER

*Designer Lever Door Handle*

LEVER ON ROSE - RECTANGULAR ROSE



Satin Chrome (SC)

## O12524ESC OIA LEVER ON RECTANGULAR ROSE

A streamlined lever on a statement rectangular rose.

Finishes: SC  
Matching WC Turn: O31WC15ESC  
Matching Key Esc: O15EKSC  
Matching Euro Esc: O15EESC  
Matching Latch: AL3SC

Base Material: Zinc Alloy  
Dimensions:  
A: 52mm B: 155mm C: 10mm D: 59mm

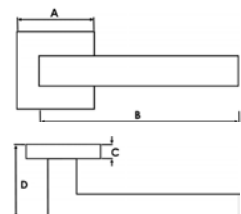



# ACE SPECIAL ORDER

## Designer Lever Door Handle

LEVER ON ROSE - RECTANGULAR ROSE



Matt Black (MB)

### O12324EMB ACE LEVER ON RECTANGULAR ROSE

A bold lever with stunning geometric details on rectangular rose.

Finishes: MB  
 Matching WC Turn: O31WC15EMB  
 Matching Key Esc: O15EKMB  
 Matching Euro Esc: O15EEMB  
 Matching Latch: AL3MB

Base Material: Zinc Alloy  
 Dimensions:  
 A: 52mm B: 155mm C: 10mm D: 69mm

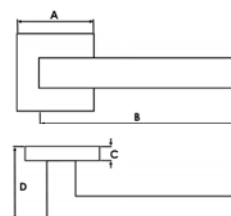

# ACCESSORIES

ESCUTCHEONS - SQUARE ROSE | WC TURN & RELEASE - SQUARE ROSE



MB



### O15EK(finish) KEY ESCUTCHEON SQUARE

Finishes: MB, SC  
 Base Material: Zamak  
 Sold with matching wood screws.  
 Dimensions: Width/Height: 52mm Depth: 10mm  
 Unit: Sold in Pairs



MB



### O15EE(finish) EURO ESCUTCHEON SQUARE

Finishes: MB, SC  
 Base Material: Zamak  
 Sold with matching wood screws.  
 Dimensions: Width/Height: 52mm Depth: 10mm  
 Unit: Sold in Pairs



MB



### O31WC15E(finish) WC TURN SQUARE

Finishes: MB, SC  
 Base Material: Zamak  
 Sold with matching wood screws.  
 Dimensions: Width/Height: 52mm Depth: 10mm  
 Unit: Sold in Pairs

# *senza pari*®



SENZA PARI DARRIO  
LEVER - SATIN BRASS

Our stunning Senza Pari collection has been designed to make a bold statement in any interior.

Living up to its name, which translates to "without equal," the Senza Pari range truly stands out with its innovative and daring designs. The collection features ultra-modern, angular shapes and distinctive curves, offering a unique contemporary and elegant look.

In a range of timeless and eye-catching finishes, there's something to suit every interior style.



SENZA PARI ROUND ROSE EURO  
ESCUTCHEON - SATIN BRASS



SENZA PARI ROUND ROSE WC  
TURN & RELEASE - SATIN BRASS



○  
—  
●  
SENZA PARI ANDRETTA  
LEVER - MATT BLACK

SENZA PARI KNURLED WC  
TURN & RELEASE - MATT  
BLACK ○  
—  
●

○



# senza pari®

Crafted to make a bold statement in any interior setting, our Senza Pari range is the perfect choice for daring design lovers. With a selection of eye-catching and considered designs, the collection features dynamic angular shapes and distinctive curves.

Available in a variety of versatile and tactile finishes, there's an option to complement every interior style.

To complete the look, the range also features a full suite of matching accessories, including WC Turn & Releases and Euro & Key Escutcheons. These coordinated elements provide a cohesive and sophisticated door solution, allowing you to achieve a detailed, unified design throughout your space.



SENZA PARI ROUND ROSE EURO  
ESCUTCHEON - MATT BLACK



SENZA PARI ROUND ROSE KEY  
ESCUTCHEON - MATT BLACK

# ANDRETTA

*Designer Lever Door Handle*

LEVER ON ROSE - ROUND ROSE



Satin Brass (SB)

**SPR160(finish) ANDRETTA** KNURLED LEVER ON ROUND MINIMAL ROSE  
With a stunning knurled texture, it has a contemporary edge.

Finishes: AB, MB, PC, SB, UDB  
Matching WC Turn: SPRKWC(finish)  
Matching Key Esc: SPRESCK(finish)  
Matching Euro Esc: SPRESCE(finish)  
Matching Latch: AL3(finish)

Base Material: Zinc Alloy  
Dimensions:  
A: 51mm B: 144mm C: 9mm D: 64mm

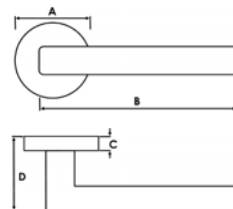

## FINISHES:



ANTIQUÉ BRASS (AB)



MATT BLACK (MB)



POLISHED CHROME (PC)



SATIN BRASS (SB)



URBAN DARK BRONZE (UDB)



# FASANA

*Designer Lever Door Handle*

LEVER ON ROSE - ROUND ROSE



Polished Chrome (PC)

**SPR165(finish) FASANA** LINEAR KNURLED LEVER ON ROUND MINIMAL ROSE  
A stylish lever with intricate linear detailing.

Finishes: AB, MB, PC, SB, UDB  
Matching WC Turn: SPRLWC(finish)  
Matching Key Esc: SPRESCK(finish)  
Matching Euro Esc: SPRESCE(finish)  
Matching Latch: AL3(finish)

Base Material: Zinc Alloy  
Dimensions:  
A: 51mm B: 144mm C: 9mm D: 64mm

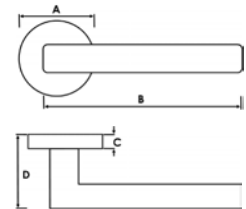

senza pari®

## FINISHES:



ANTIQUÉ BRASS (AB)



MATT BLACK (MB)



POLISHED CHROME (PC)



SATIN BRASS (SB)



URBAN DARK BRONZE (UDB)



# ROSARNO

*Designer Lever Door Handle*

LEVER ON ROSE - ROUND ROSE



Matt Black (MB)

**SPR170(finish) ROSARNO** KNURLED LEVER ON ROUND MINIMAL ROSE  
Stunning knurled details with a modern, contemporary feel.

Finishes: AB, MB, PC, SB, UDB  
Matching WC Turn: SPRKWC(finish)  
Matching Key Esc: SPRESCK(finish)  
Matching Euro Esc: SPRESCE(finish)  
Matching Latch: AL3(finish)

Base Material: Zinc Alloy  
Dimensions:  
A: 51mm B: 145mm C: 9mm D: 62mm

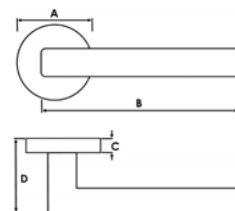

## FINISHES:



ANTIQUÉ BRASS (AB)



MATT BLACK (MB)



POLISHED CHROME (PC)



SATIN BRASS (SB)



URBAN DARK BRONZE (UDB)





# LAVIANO

*Designer Lever Door Handle*

LEVER ON ROSE - ROUND ROSE

senza pari®



Satin Brass (SB)

**SPR180(finish) LAVIANO LEVER ON ROUND MINIMAL ROSE**

Sleek and modern with a timeless feel.

Finishes: AB, MB, PC, SB, UDB  
 Matching WC Turn: SPRWC(finish)  
 Matching Key Esc: SPRESCK(finish)  
 Matching Euro Esc: SPRESCE(finish)  
 Matching Latch: AL3(finish)

Base Material: Zinc Alloy  
 Dimensions:  
 A: 51mm B: 135mm C: 9mm D: 60mm

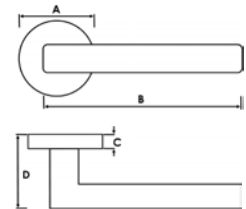

## FINISHES:



ANTIQUÉ BRASS (AB)



MATT BLACK (MB)



POLISHED CHROME (PC)



SATIN BRASS (SB)



URBAN DARK BRONZE (UDB)

# DARRIO

*Designer Lever Door Handle*

LEVER ON ROSE - ROUND ROSE



Urban Dark Bronze (UDB)

**SPRO218(finish) DARRIO LEVER ON ROUND ROSE**

A streamlined design with a contemporary touch.

Finishes: AB, MB, PC, SB, SN, UDB  
 Matching WC Turn: SPROWC(finish)  
 Matching Key Esc: SPROESCK(finish)  
 Matching Euro Esc: SPROESCE(finish)  
 Matching Latch: AL3(finish)

Base Material: Zinc Alloy  
 Dimensions:  
 A: 56mm B: 124mm C: 11mm D: 65mm

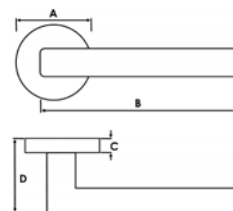

## FINISHES:



ANTIQUÉ BRASS (AB)



MATT BLACK (MB)



POLISHED CHROME (PC)



SATIN BRASS (SB)



SATIN NICKEL (SN)



URBAN DARK BRONZE (UDB)



# PANETTI

*Designer Lever Door Handle*  
LEVER ON ROSE - SQUARE ROSE

senza pari®

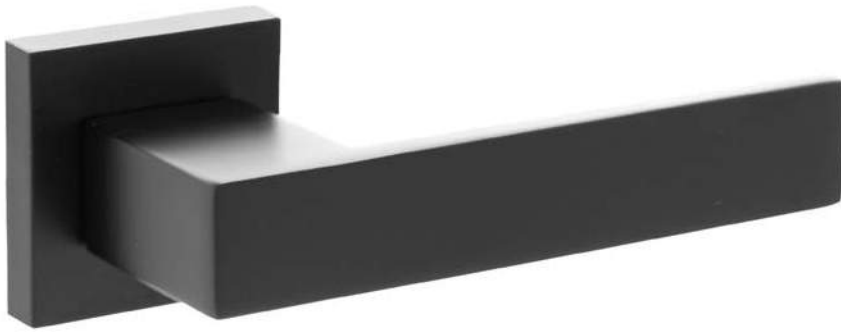

Matt Black (MB)

## SP217(finish) PANETTI LEVER ON SQUARE ROSE

A modern lever with a sleek, square rose.

Finishes: MB, CP, SB, SN  
Matching WC Turn: SPWC(finish)  
Matching Key Esc: SPESCK(finish)  
Matching Euro Esc: SPESCE(finish)  
Matching Latch: AL3(finish)

Base Material: Zinc Alloy  
Dimensions:  
A: 55mm B: 134mm C: 10mm D: 59mm

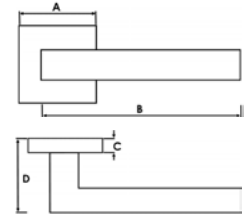

## FINISHES:



MATT BLACK (MB)



POLISHED CHROME (CP)



SATIN BRASS (SB)



SATIN NICKEL (SN)

# GUIDO

*Designer Lever Door Handle*

LEVER ON ROSE - SQUARE ROSE



Matt Black (MB)

## SP190(finish) GUIDO LEVER ON SQUARE ROSE

A stunning and unique twisted lever on a minimal square rose.

Finishes: MB, CP, SN

Matching WC Turn: SPWC(finish)

Matching Key Esc: SPESCK(finish)

Matching Euro Esc: SPESCE(finish)

Matching Latch: AL3(finish)

Base Material: Zinc Alloy

Dimensions:

A: 55mm B: 139mm C: 10mm D: 62mm

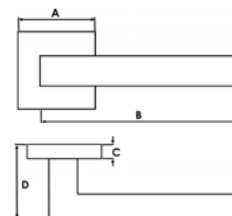

## FINISHES:



MATT BLACK (MB)



POLISHED CHROME (CP)



SATIN NICKEL (SN)

# GIOVANNI

*Designer Lever Door Handle*

LEVER ON ROSE - SQUARE ROSE



Satin Nickel (SN)

## SP203SN GIOVANNI LEVER ON SQUARE ROSE

A standout lever with a statement design.

Finishes: SN

Matching WC Turn: SPWC3SN

Matching Key Esc: SPESCKSN

Matching Euro Esc: SPESCESN

Matching Latch: AL3SN

Base Material: Zinc Alloy

Dimensions:

A: 55mm B: 132mm C: 10mm D: 68mm

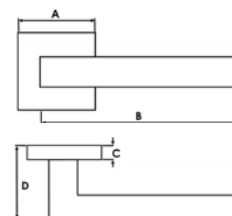

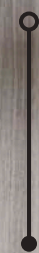

SENZA PARI GUIDO  
LEVER - MATT BLACK

# DAVOLI

*Designer Lever Door Handle*

LEVER ON ROSE - SQUARE ROSE



Polished Chrome (PC)

## SP216(finish) DAVOLI LEVER ON SQUARE ROSE

A refined design that exudes modern sophistication.

Finishes: PC, SN

Matching WC Turn: SPWC(finish)

Matching Key Esc: SPESCK(finish)

Matching Euro Esc: SPESCE(finish)

Matching Latch: AL3(finish)

Base Material: Zinc Alloy

Dimensions:

A: 55mm B: 128mm C: 10mm D: 61mm

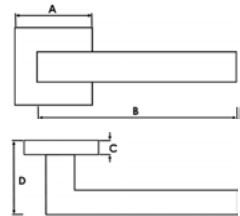

## FINISHES:



POLISHED CHROME (PC)



SATIN NICKEL (SN)

# ELISSE

*Designer Lever Door Handle*

LEVER ON ROSE - ROUND ROSE



Satin Nickel / Polished Chrome (SNCP)

## SPM222SNCP ELISSE LEVER ON ROUND ROSE

A contemporary statement lever.

Finishes: SNCP

Matching WC Turn: SPMWCSNCP

Matching Key Esc: SPMESCKSNCP

Matching Euro Esc: SPMESCESNCP

Matching Latch: AL3SN

Base Material: Zinc Alloy

Dimensions:

A: 51mm B: 130mm C: 10mm D: 60mm

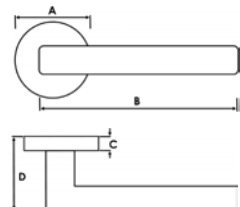

# BIANCA

*Designer Lever Door Handle*

LEVER ON ROSE - SQUARE ROSE



Satin Nickel (SN)

## SPC193SN BIANCA LEVER ON SQUARE ROSE

A unique, statement lever.

Finishes: SN  
 Matching WC Turn: SPCWCSN  
 Matching Key Esc: SPCESCKSN  
 Matching Euro Esc: SPCESCESN  
 Matching Latch: AL3SN

Base Material: Zinc Alloy  
 Dimensions:  
 A: 51mm B: 130mm C: 10mm D: 61mm

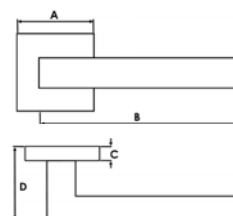

# CRYSTAL

*Designer Lever Door Handle*

LEVER ON ROSE - ROUND ROSE



Crystal Polished Chrome (CRCP)

## SPM167CRCP CRYSTAL LEVER ON ROUND ROSE

A luxurious feel lever with a stunning inlay of crystals.

Finishes: CRCP  
 Matching WC Turn: SPMWCCP  
 Matching Key Esc: SPMESCKCP  
 Matching Euro Esc: SPMESCECP  
 Matching Latch: AL3PC

Base Material: Zinc Alloy  
 Dimensions:  
 A: 51mm B: 140mm C: 10mm D: 69mm

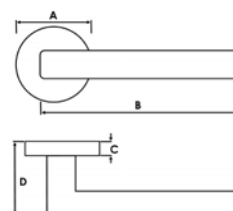

senza pari®

# ACCESSORIES

ESCUTCHEONS - ROUND & SQUARE ROSE | WC TURN & RELEASE - ROUND & SQUARE ROSE



## SPRESCE(finish) EURO ESCUTCHEON MINIMAL ROUND

Finishes: AB, MB, PC, SB, UDB

Base Material: Zinc Alloy

Sold with matching wood screws.

Compatible with all Atlantic locks.

Dimensions: Width/Height: 51mm Depth: 9mm

Unit: Sold in Pairs



## SPROESCE(finish) EURO ESCUTCHEON ROUND

Finishes: AB, MB, PC, SB, SN, UDB

Base Material: Zinc Alloy

Sold with matching wood screws.

Compatible with all Atlantic locks.

Dimensions: Width/Height: 56mm Depth: 11mm

Unit: Sold in Pairs



## SPRESCK(finish) KEY ESCUTCHEON MINIMAL ROUND

Finishes: AB, MB, PC, SB, UDB

Base Material: Zinc Alloy

Sold with matching wood screws.

Compatible with all Atlantic locks.

Dimensions: Width/Height: 51mm Depth: 9mm

Unit: Sold in Pairs



## SPROESCK(finish) KEY ESCUTCHEON ROUND

Finishes: AB, MB, PC, SB, SN, UDB

Base Material: Zinc Alloy

Sold with matching wood screws.

Compatible with all Atlantic locks.

Dimensions: Width/Height: 56mm Depth: 11mm

Unit: Sold in Pairs



## SPRKWC(finish) KNURLED WC TURN & RELEASE MINIMAL ROUND

Finishes: AB, MB, PC, SB, UDB

Base Material: Zinc Alloy

Sold with matching wood screws.

Dimensions: Width/Height: 51mm Depth: 9mm

Projection: 33mm



## SPRLWC(finish) LINEAR KNURLED WC TURN & RELEASE MINIMAL ROUND

Finishes: AB, MB, PC, SB, UDB

Base Material: Zinc Alloy

Sold with matching wood screws.

Dimensions: Width/Height: 51mm Depth: 9mm

Projection: 33mm



## SPROWC(finish) WC TURN & RELEASE ROUND

Finishes: AB, MB, PC, SB, SN, UDB

Base Material: Zinc Alloy

Sold with matching wood screws.

Dimensions: Width/Height: 56mm Depth: 11mm

Projection: 36mm



## SPRWC(finish) WC TURN & RELEASE ROUND

Finishes: AB, MB, PC, SB, UDB

Base Material: Zinc Alloy

Sold with matching wood screws.

Dimensions: Width/Height: 51mm Depth: 9mm

Projection: 37mm



## SPMWC(finish) WC TURN & RELEASE ROUND

Finishes: CP, SNCP, SNNP

Base Material: Zinc Alloy

Sold with matching wood screws.

SPMWCWAB - This product requires a bolt through fixing method therefore this must be fitted with ADBCE or ASDB Deadbolts only.

CP, SNCP, SNNP - Compatible with all Atlantic locks.

Dimensions: Width/Height: 51mm Depth: 10mm

Projection: 40mm

senza pari®



# ACCESSORIES

ESCUTCHEONS - ROUND & SQUARE ROSE | WC TURN & RELEASE - ROUND & SQUARE ROSE



SNCP

CP SNCP SNNP



## SPMESCK(finish) KEY ESCUTCHEON ROUND

Finishes: CP, SNCP, SNNP

Base Material: Zinc Alloy

Sold with matching wood screws.

Compatible with all Atlantic locks.

Dimensions: Width/Height: 51mm Depth: 10mm

Unit: Sold in Pairs



SNCP

CP SNCP SNNP



## SPMESCE(finish) EURO ESCUTCHEON ROUND

Finishes: CP, SNCP, SNNP

Base Material: Zinc Alloy

Sold with matching wood screws.

Compatible with all Atlantic locks.

Dimensions: Width/Height: 51mm Depth: 10mm

Unit: Sold in Pairs



MB

CP MB SB SN



## SPECK(finish) KEY ESCUTCHEON SQUARE

Finishes: CP, MB, SB, SN

Base Material: Zinc Alloy

Sold with matching wood screws.

Not compatible with any Atlantic locks.

Dimensions: Width/Height: 55mm Depth: 10mm

Unit: Sold in Pairs



SN

SN SNNP



## SPCESCK(finish) KEY ESCUTCHEON SQUARE

Finishes: SN, SNNP

Base Material: Zinc Alloy

Sold with matching wood screws.

Compatible with all Atlantic locks.

Dimensions: Width/Height: 51mm Depth: 10mm

Unit: Sold in Pairs



SB

CP MB SB SN



## SPECE(finish) EURO ESCUTCHEON SQUARE

Finishes: CP, MB, SB, SN

Base Material: Zinc Alloy

Sold with matching wood screws.

Compatible with all Atlantic Euro Mortice locks.

Dimensions: Width/Height: 55mm Depth: 10mm

Unit: Sold in Pairs



SN

SN SNNP



## SPCESCE(finish) EURO ESCUTCHEON SQUARE

Finishes: SN, SNNP

Base Material: Zinc Alloy

Sold with matching wood screws.

Compatible with all Atlantic locks.

Dimensions: Rose Width/Height: 51mm Depth: 10mm

Unit: Sold in Pairs



PC

MB PC SB



## SPWC(finish) WC TURN & RELEASE SQUARE

Finishes: MB, PC, SB

Base Material: Zinc Alloy

Sold with matching wood screws.

Dimensions: Width/Height: 52mm Depth: 10mm

Projection: 36mm



SN

## SPWCSN WC TURN & RELEASE SQUARE

Base Material: Zinc Alloy

Sold with matching wood screws.

This product requires a bolt through fixing method therefore

this must be fitted with ADBCE or ASDB Deadbolts only.

Dimensions: Rose Width/Height: 55mm Rose Depth: 10mm

Projection: 40mm



SN

SN SNNP



## SPCWC(finish) WC TURN & RELEASE SQUARE

Finishes: SN, SNNP

Base Material: Zinc Alloy

Sold with matching wood screws.

This product requires a bolt through fixing method therefore

this must be fitted with ADBCE or ASDB Deadbolts only.

Dimensions: Rose Width/Height: 55mm Rose Depth: 10mm

Projection: 40mm

senza pari®

# Old English<sup>®</sup>

Brimming with vintage charm, our Old English collection captures the traditional and timeless feel of Britain's architectural heritage.

With 15 stunning finishes to choose from and multiple options of lever on rose, lever on backplate or mortice knob, there is something to add that distinctive finishing touch to your project.

Bringing a contemporary twist to classic looks, the collection features elegant solid brass mortice knobs alongside stunning reeded design details.

With an authentic feel, but all the convenience of a modern fitting, our Old English range is the perfect choice for any restoration project.



OLD ENGLISH OVAL WC TURN  
& RELEASE - ANTIQUE BRASS



OLD ENGLISH HARROGATE  
MORTICE KNOB - ANTIQUE BRASS

OLD ENGLISH RIPON REEDED  
MORTICE KNOB - ANTIQUE BRASS

OLD ENGLISH  
OPEN KEY HOLE  
ESCUTCHEON -  
ANTIQU BRASS



# Old English<sup>®</sup>

Bring the charm of traditional architecture back to life with our Old English collection. From ornate door handles to antique hinges, our products are designed to blend perfectly with your restoration project.

Combining classic aesthetics with a contemporary feel, the collection features striking and tactile finishes such as Matt Gun Metal and Antique Brass. Alternatively, pair with chic finishes such as sleek Matt Black or Urban Dark Bronze for a modern twist.

OLD ENGLISH OPEN KEY HOLE  
ESCUTCHEON - DISTRESSED SILVER

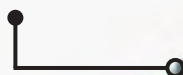

OLD ENGLISH DURHAM  
LEVER - DISTRESSED SILVER



OLD ENGLISH WARWICK LEVER - MATT GUN METAL



OLD ENGLISH OVAL WC TURN & RELEASE - MATT GUN METAL



OLD ENGLISH OPEN KEY HOLE ESCUTCHEON - MATT GUN METAL



OLD ENGLISH OVAL WC TURN & RELEASE - DISTRESSED SILVER



# WARWICK

*Designer Lever Door Handle*

LEVER ON ROSE - ROUND ROSE



Distressed Silver (DS)

**OE178(finish) WARWICK LEVER ON ROUND ROSE**

An authentic, classic style with the durability of a modern lever.

Other Finishes: AB, DS, MAB, MB, MBN, UDB  
 Matching WC Turn: OEWC(finish)  
 Matching Key Esc: OEESCK(finish)  
 Matching Euro Esc: OEESCEDS(finish)  
 Matching Latch: AL3(finish)

Base Material: Zinc Alloy  
 Dimensions:  
 A: 51mm B: 121mm C: 10mm D: 70mm

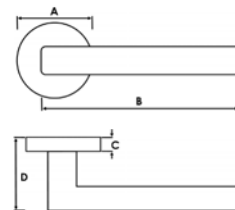

## FINISHES:



ANTIQUe BRASS (AB)



DISTRESSED SILVER (DS)



MATT ANTIQUe BRASS (MAB)



MATT BLACK (MB)



MATT GUN METAL (MBN)



URBAN DARK BRONZE (UDB)

# COLCHESTER

## Designer Lever Door Handle

LEVER ON ROSE - ROUND ROSE



Antique Brass (AB)

### OE177(finish) COLCHESTER LEVER ON ROUND ROSE

A traditional style lever, made for modern day living.

Finishes: AB, DS, MBN  
 Matching WC Turn: OEWC(finish)  
 Matching Key Esc: OEESCK(finish)  
 Matching Euro Esc: OEESCE(finish)

Matching Latch: AL3(finish)  
 Base Material: Zinc Alloy  
 Dimensions:  
 A: 51mm B: 112mm C: 10mm D: 64mm

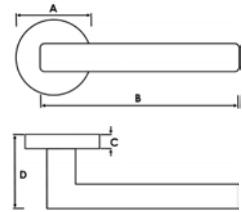

### FINISHES:



ANTIQUE BRASS (AB)



DISTRESSED SILVER (DS)



MATT GUN METAL (MBN)

# DURHAM

## Designer Lever Door Handle

LEVER ON ROSE - ROUND ROSE



Matt Gun Metal (MBN)

### OE127(finish) DURHAM LEVER ON ROUND ROSE

A statement, traditional lever with linear design details.

Finishes: DS, MBN  
 Matching WC Turn: OEWC(finish)  
 Matching Key Esc: OEESCK(finish)  
 Matching Euro Esc: OEESCE(finish)

Matching Latch: AL3(finish)  
 Base Material: Zinc Alloy  
 Dimensions:  
 A: 51mm B: 129mm C: 10mm D: 65mm

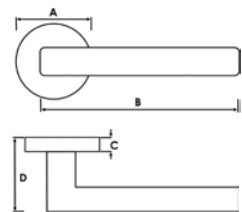

### FINISHES:



DISTRESSED SILVER (DS)



MATT GUN METAL (MBN)

# RICHMOND

*Designer Lever Door Handle*

LEVER ON ROSE - ROUND ROSE



Matt Gun Metal (MBN)

## OE110(finish) RICHMOND LEVER ON ROUND ROSE

Linear design details on a stunning traditional feel lever.

Other Finishes: DS, MBN

Matching WC Turn: OEWC(finish)

Matching Key Esc: OEESCK(finish)

Matching Euro Esc: OEESCE(finish)

Matching Latch: AL3(finish)

Base Material: Zinc Alloy

Dimensions:

A: 51mm B: 133mm C: 10mm D: 66mm

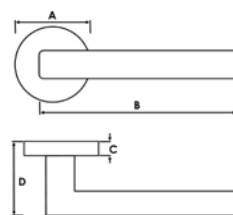

## FINISHES:



DISTRESSED SILVER (DS)



MATT GUN METAL (MBN)

# WREXHAM

*Designer Lever Door Handle*

LEVER ON ROSE - ROUND ROSE



Matt Antique Brass (MAB)

## OE142MAB WREXHAM LEVER ON ROUND ROSE MAB

Curved details paired with a classic feel.

Finishes: MAB

Matching WC Turn: OEWCMB

Matching Key Esc: OEESCKMAB

Matching Euro Esc: OEESCEMAB

Matching Latch: AL3MAB

Base Material: Zinc Alloy

Dimensions:

A: 51mm B: 129mm C: 10mm D: 65mm

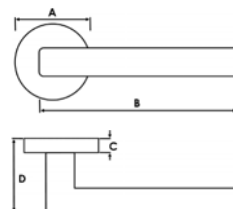



# OXFORD

*Designer Lever Door Handle*

LEVER ON ROSE - ROUND ROSE



Matt Antique Brass (MAB)

## OE144MAB OXFORD LEVER ON ROUND ROSE MAB

Oxford has an elegant, etched curved form.

Finishes: MAB  
Matching WC Turn: OEWCMBAB  
Matching Key Esc: OEESCKMAB  
Matching Euro Esc: OEESCEMAB  
Matching Latch: AL3MAB

Base Material: Zinc Alloy  
Dimensions:  
A: 51mm B: 128mm C: 10mm D: 65mm

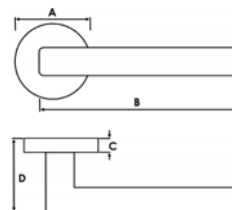

# CAMBRIDGE

*Designer Lever Door Handle*

LEVER ON ROSE - ROUND ROSE



Matt Antique Brass (MAB)

## OE175MAB CAMBRIDGE LEVER ON ROUND ROSE MAB

Intricate design details with an authentic feel.

Finishes: MAB  
Matching WC Turn: OEWCMBAB  
Matching Key Esc: OEESCKMAB  
Matching Euro Esc: OEESCEMAB  
Matching Latch: AL3MAB

Base Material: Zinc Alloy  
Dimensions:  
A: 51mm B: 124mm C: 10mm D: 74mm

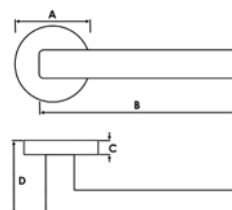

# WARWICK

*Designer Lever on Backplate*  
LEVER ON BACKPLATE



Distressed Silver (DS)

**OE178L(finish) WARWICK LEVER ON BACKPLATE**  
A stunning combination of traditional & contemporary styles.

Finishes: AB, DS, MAB, MB, MBN, UDB  
Matching Latch: AL3(finish)  
Base Material: Zinc Alloy

Dimensions  
Backplate Width: 50mm  
Handle Length: 121mm  
Backplate Length: 168mm  
Backplate Depth: 9mm  
Backplate & Lever Projection: 62mm

## FINISHES:



ANTIQUE BRASS (AB)



DISTRESSED SILVER (DS)



MATT ANTIQUE BRASS (MAB)



MATT BLACK (MB)



MATT GUN METAL (MBN)



URBAN DARK BRONZE (UDB)

# WARWICK

## Designer Lever on Backplate

LEVER ON BACKPLATE



Matt Antique Brass (MAB)

**OE178K(finish) WARWICK LEVER ON KEY BACKPLATE**  
A stunning combination of traditional & contemporary styles.

Other Finishes: AB, DS, MAB, MB, MBN, UDB  
Matching Lock: ALKSASH3LK3(finish)  
Base Material: Zinc Alloy  
Centre to Centre: 55mm

### FINISHES:



ANTIQUÉ BRASS (AB)



DISTRESSED SILVER (DS)



MATT ANTIQUÉ BRASS (MAB)



MATT BLACK (MB)



MATT GUN METAL (MBN)



URBAN DARK BRONZE (UDB)



Distressed Silver (DS)

**OE178WC(finish) WARWICK LEVER ON WC TURN BACKPLATE**  
A stunning combination of traditional & contemporary styles.

Finishes: AB, DS, MAB, MB, MBN, UDB  
Matching Latch: AL3(finish)  
Base Material: Zinc Alloy

Other Finishes: AB, DS, MAB, MB, MBN, UDB  
Matching Lock: ALKBATH3(finish)  
Base Material: Zinc Alloy  
Centre to Centre: 60mm

### FINISHES:



ANTIQUÉ BRASS (AB)



DISTRESSED SILVER (DS)



MATT ANTIQUÉ BRASS (MAB)



MATT BLACK (MB)



MATT GUN METAL (MBN)



URBAN DARK BRONZE (UDB)

# RIPON

## Round Reeded Mortice Knob

MORTICE KNOB - CONCEALED FIX ROSE



Matt Black (MB)

### OE50RMK(finish) RIPON ROUND REEDED MORTICE KNOB

Striking reeded details on a classic mortice knob.

#### CONCEALED FIX

Finishes Available: AB, AC, DS, MAB, MB, MBN, PB, PC, PN, RB, SC, SN, UB, UDB

Matching WC Turn: OEOWC(finish)

Matching Open Key Esc: OERKE(finish)

Matching Latch: AL3 or AL4(finish)

Base Material: Solid Brass

Dimensions:

Knob Diameter: 50mm

Projection: 76mm

Rose Diameter: 70mm

Our Mortice Knobs are not recommended for use with our Bathlocks & Sashlocks because they are unsprung and require heavy duty locks. We recommend using our AL3 or AL4 latches and ADB deadbolts, or our DIN Standard Locks.

## FINISHES:



ANTIQUe BRASS (AB)



ANTIQUe COPPER (AC)



DISTRESSeD SILVER (DS)



FINISHES (CONT.):



MATT ANTIQUE BRASS (MAB)



MATT BLACK (MB)



MATT GUN METAL (MBN)



POLISHED BRASS (PB)



POLISHED CHROME (PC)



POLISHED NICKEL (PN)



UNLACQUERED BRASS / RAW BRASS (RB)



SATIN CHROME (SC)



SATIN NICKEL (SN)



URBAN BRONZE (UB)



URBAN DARK BRONZE (UDB)

# HARROGATE

## Mushroom Mortice Knob

MORTICE KNOB - CONCEALED FIX ROSE



Matt Antique Brass (MAB)

### OE58MMK(finish) HARROGATE MUSHROOM MORTICE KNOB

A classic and timeless design.

#### CONCEALED FIX

Finishes Available: AB, AC, BN, DS, MAB, MB, MBN, PB, PC, PN, RB, SB, SC, SN, UB, UDB, USC  
 Matching WC Turn: OEOWC(finish)  
 Matching Open Key Esc: OERKE(finish)  
 Matching Latch: AL3 or AL4(finish)

Base Material: Solid Brass

Dimensions:

Knob Diameter: 58mm

Projection: 70mm

Rose Diameter: 65mm

Our Mortice Knobs are not recommended for use with our Bathlocks & Sashlocks because they are unsprung and require heavy duty locks. We recommend using our AL3 or AL4 latches and ADB deadbolts, or our DIN Standard Locks.

## FINISHES:



ANTIQUe BRASS (AB)

ANTIQUe COPPER (AC)

BLACK NICKEL (BN)



---

## FINISHES (CONT.):



DISTRESSED SILVER (DS)



MATT ANTIQUE BRASS (MAB)



MATT BLACK (MB)



MATT GUN METAL (MBN)



POLISHED BRASS (PB)



POLISHED CHROME (PC)



POLISHED NICKEL (PN)



UNLACQUERED BRASS / RAW  
BRASS (RB)



SATIN BRASS (SB)



SATIN CHROME (SC)



SATIN NICKEL (SN)



URBAN BRONZE (UB)



URBAN DARK BRONZE (UDB)



URBAN SATIN COPPER (USC)

OLD ENGLISH HARROGATE KNOB  
- ANTIQUE COPPER







# WHITBY

## *Ebony Wood Mortice Knob*

MORTICE KNOB - FACE FIX ROSE

All Atlantic knobs are unsprung so must be fitted with a heavy duty double sprung tubular latch. Ensure latch chosen provides sufficient backset to distance the knob from the door frame. On fire door frames we recommend 4" heavy duty latches with knobs and 3" on a standard frame.



Satin Nickel (SN)

### **OE60RREMK(finish) WHITBY ROUND REEDED EBONY WOOD MORTICE KNOB ON ROSE**

A refined option for any traditional setting.

**FACE FIX**

Finishes: PB, PN, SN

Matching WC Turn: OEOWC(finish)

Matching Open Key Esc: OERKE(finish)

Matching Latch: AL3 or AL4(finish)

Rose Material: Solid Brass

Knob Material: Ebony Wood

Sold with matching wood screws.

Dimensions

Knob Diameter: 55mm

Projection: 85mm

Rose Diameter: 59mm

Our Mortice Knobs are not recommended for use with our Bathlocks & Sashlocks because they are unsprung and require heavy duty locks. We recommend using our AL3 or AL4 latches and ADB deadbolts, or our DIN Standard Locks.

## FINISHES:



POLISHED BRASS (PB)



POLISHED NICKEL (PN)



SATIN NICKEL (SN)



# BRIDLINGTON

*Designer Wood Mortice Knob*

MORTICE KNOB - FACE FIX ROSE



**OE57RMK(finish) BRIDLINGTON** WOOD REEDED BEEHIVE DOOR KNOB ON FACE FIX ROSE  
A reeded wooden design, perfect for adding a finishing touch for cottages, listed buildings and period properties.

FACE FIX  
Finishes Available: AB, PB, SN  
Matching WC Turn: OEOWC(finish)  
Matching Open Key Esc: OERKE(finish)  
Matching Latch: AL3 or AL4(finish)  
Base Material: Solid Brass

Dimensions  
Knob Diameter: 57mm  
Projection: 90mm  
Rose Diameter: 59mm

Our Mortice Knobs are not recommended for use with our Bathlocks & Sashlocks because they are unsprung and require heavy duty locks. We recommend using our AL3 or AL4 latches and ADB deadbolts, or our DIN Standard Locks.

## FINISHES:



ANTIQUÉ BRASS (AB)



POLISHED BRASS (PB)



SATIN NICKEL (SN)



# SKIPTON

*Designer Porcelain Mortice Knob*

MORTICE KNOB - FACE FIX ROSE



Old English®

**OE59CMKWH(finish) SKIPTON PORCELAIN WHITE CRACKLE DOOR KNOB ON FACE FIX ROSE**  
 A statement mortice knob with a traditional and classic design.

FACE FIX  
 Finishes: AB, MB, PC  
 Code for **Antique Brass** finish: **OE59CMKCAB**  
 Matching WC Turn: OEWOC(finish)  
 Matching Open Key Esc: OERKE(finish)  
 Matching Latch: AL3 or AL4(finish)

Sold with matching wood screws.  
 Dimensions:  
 Knob Diameter: 59mm  
 Projection: 85mm  
 Rose Diameter: 70mm

Our Mortice Knobs are not recommended for use with our Bathlocks & Sashlocks because they are unsprung and require heavy duty locks. We recommend using our AL3 or AL4 latches and ADB deadbolts, or our DIN Standard Locks.

## FINISHES:



ANTIQUE BRASS (AB)  
 OE59CMKCAB



MATT BLACK (MB)



POLISHED CHROME (PC)

# ACCESSORIES

## ESCUTCHEONS | WC TURN & RELEASE



DS

### OERKE(finish) OPEN KEY ESCUTCHEON ROUND

Finishes: AB, AC, BN, DS, MAB, MB, MBN, PB, PC, PN, RB, SB, SC, SN, UB, UDB, USC  
 Base Material: Solid Brass  
 Sold with matching wood screws.

Dimensions: Diameter: 42mm  
 Unit: Sold in Pairs



DS

### OEOWC(finish) WC TURN & RELEASE ROUND

Finishes: AB, AC, BN, DS, MAB, MB, MBN, PB, PC, PN, RB, SB, SC, SN, UB, UDB, USC  
 Base Material: Solid Brass  
 Sold with matching wood screws.

Dimensions: Rose Diameter: 42mm  
 Knob: 31 x 19mm



MBN



### OESCK(finish) KEY ESCUTCHEON ROUND

Finishes: AB, DS, MAB, MB, MBN, UDB  
 Base Material: Zinc Alloy  
 Sold with matching wood screws.

Dimensions: Width/Height: 50mm Depth: 10mm  
 Unit: Sold in Pairs



MBN



### OESCE(finish) EURO ESCUTCHEON ROUND

Finishes: AB, DS, MAB, MB, MBN, UDB  
 Base Material: Zinc Alloy  
 Sold with matching wood screws.

Dimensions: Width/Height: 50mm Depth: 10mm  
 Unit: Sold in Pairs



MBN



### OEWC(finish) WC TURN & RELEASE ROUND

Finishes: AB, DS, MAB, MB, MBN, UDB  
 Base Material: Zinc Alloy  
 Sold with matching wood screws.

Dimensions: Width/Height: 50mm Depth: 10mm  
 Projection: 45mm

Old English Cabinet Hardware Range is also available. See page 191.



# Mediterranean®

MEDITERRANEAN MALTA  
LEVER - SATIN NICKEL



Our Mediterranean collection showcases a distinctive range of elegant and contemporary levers, meticulously crafted to the highest standards to provide a refined finishing touch for your interior. Drawing inspiration from the relaxed and inviting spirit of Mediterranean living, this range is designed to make a subtle yet striking statement.

MEDITERRANEAN "C" ROUND ROSE  
EURO ESCUTCHEON - SATIN NICKEL

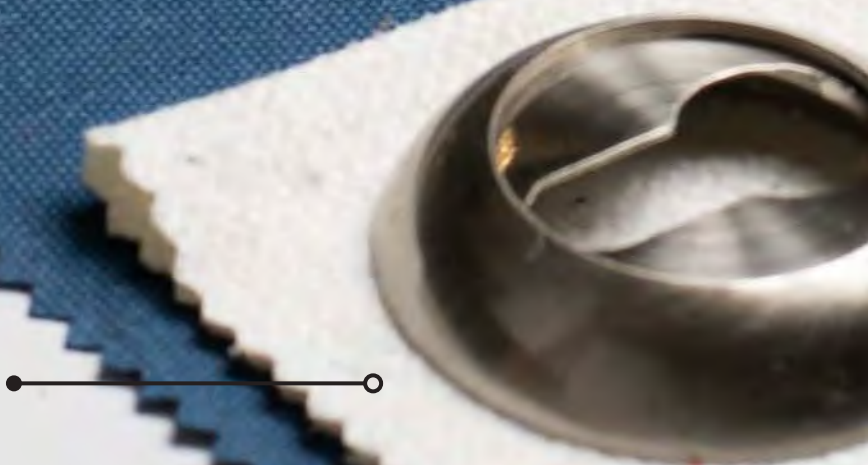

MEDITERRANEAN "C" ROUND ROSE  
WC TURN & RELEASE - SATIN NICKEL



MEDITERRANEAN ROUND ROSE WC  
TURN & RELEASE - SATIN NICKEL

MEDITERRANEAN BARCELONA  
LEVER - SATIN NICKEL

MEDITERRANEAN ROUND  
ROSE EURO ESCUTCHEON  
- SATIN NICKEL



# Mediterranean<sup>®</sup>

The range features over 5 stunning finishes. From the warm, inviting tones of Satin Nickel to the luxurious gleam of Polished Brass, there's something to suit every scheme.

With a focus on contemporary stylish designs, the collection includes smooth, sleek options such as the Malta and Malaga levers. For an elevated sophisticated look, the Santorini lever features a stunning dual finish of Satin Chrome and Polished Chrome.



# BARCELONA

## Designer Lever Door Handle

LEVER ON ROSE - ROUND ROSE



Polished Brass (BP)

### M86(finish) BARCELONA LEVER ON ROUND ROSE

A statement, curved lever design.

Finishes: BP, SN  
Matching WC Turn: MWC(finish)  
Matching Key Esc: MESCK(finish)  
Matching Euro Esc: MESCE(finish)  
Matching Latch: AL3(finish)

Base Material: Zinc Alloy  
Dimensions:  
A: 51mm B: 130mm C: 10mm D: 64mm

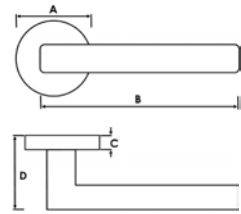

## FINISHES:



POLISHED BRASS (BP)



SATIN NICKEL (SN)

# MALTA

## Designer Lever Door Handle

LEVER ON ROSE - ROUND ROSE



Polished Chrome (PC)

### MC25(finish) MALTA LEVER ON 'C' ROUND ROSE

An eye-catching, bold lever design.

Finishes: PC, SN  
Matching WC Turn: MCWC(finish)  
Matching Key Esc: MCESCK(finish)  
Matching Euro Esc: MCESCE(finish)  
Matching Latch: AL3(finish)

Base Material: Zinc Alloy  
Dimensions:  
A: 55mm B: 130mm C: 10mm D: 61mm

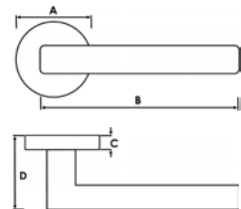

## FINISHES:



POLISHED CHROME (CP)



SATIN NICKEL (SN)

# MALAGA

*Designer Lever Door Handle*

LEVER ON ROSE - ROUND ROSE



Satin Nickel (SN)

**M27SN MALAGA LEVER ON ROUND ROSE**  
A contemporary, eye-catching lever with bold curves.

Finishes: SN  
Matching WC Turn: MWCSN  
Matching Key Esc: MESCKSN  
Matching Euro Esc: MESCESN  
Matching Latch: AL3SN

Base Material: Zinc Alloy  
Dimensions:  
A: 51mm B: 130mm C: 10mm D: 67mm

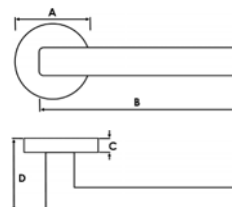

# CORSICA

*Designer Lever Door Handle*

LEVER ON ROSE - ROUND ROSE



Satin Nickel (SN)

**M60SN CORSICA LEVER ON ROUND ROSE**  
Satin Nickel coats Corsica creating a glamorous, modern handle design.

Finishes: SN  
Matching WC Turn: MWCSN  
Matching Key Esc: MESCKSN  
Matching Euro Esc: MESCESN  
Matching Latch: AL3SN

Base Material: Zinc Alloy  
Dimensions:  
A: 51mm B: 124mm C: 10mm D: 66mm

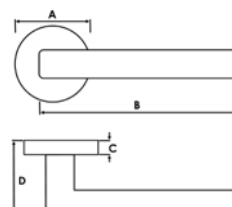



# MARSEILLE

*Designer Lever Door Handle*

LEVER ON ROSE - ROUND ROSE



Satin Nickel (SN)

**M70SN MARSEILLE LEVER ON ROUND ROSE**  
A sleek, contemporary and unique lever design

Finishes: SN  
Matching WC Turn: MWCSN  
Matching Key Esc: MESCKSN  
Matching Euro Esc: MESCESN  
Matching Latch: AL3SN

Base Material: Zinc Alloy  
Dimensions:  
A: 51mm B: 124mm C: 10mm D: 64mm

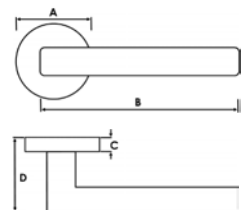

# GIBRALTAR

*Designer Lever Door Handle*

LEVER ON ROSE - ROUND ROSE



Satin Nickel / Nickel Plate (SNNP)

## M83SNNP GIBRALTAR LEVER ON ROUND ROSE

Gibraltar has a unique lever form coated in polished and satin nickel.

Finishes: SNNP  
Matching WC Turn: MWCSNNP  
Matching Key Esc: MESCKSNNP  
Matching Euro Esc: MESCESNNP  
Matching Latch: AL3SN

Base Material: Zinc Alloy  
Dimensions:  
A: 51mm B: 125mm C: 10mm D: 66mm

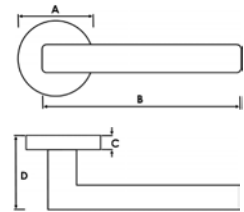

# VALENCIA

*Designer Lever Door Handle*

LEVER ON ROSE - ROUND ROSE



Satin Nickel / Nickel Plate (SNNP)

## M85(finish) VALENCIA LEVER ON ROUND ROSE

A modern, streamlined lever design with curved features.

Finishes: BP, SNNP  
Matching WC Turn: MWC(finish)  
Matching Key Esc: MESCK(finish)  
Matching Euro Esc: MESCE(finish)  
Matching Latch: AL3(finish)

Base Material: Zinc Alloy  
Dimensions:  
A: 51mm B: 120mm C: 10mm D: 65mm

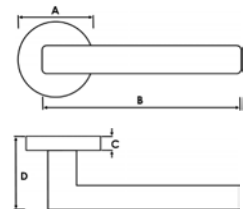

## FINISHES:



POLISHED BRASS (BP)



SATIN NICKEL / NICKEL PLATE (SNNP)

# MESSINA

*Designer Lever Door Handle*

LEVER ON ROSE - ROUND ROSE



Satin Nickel / Nickel Plate  
(SNNP)

**M53SNNP MESSINA LEVER ON ROUND ROSE**  
A contemporary lever with a distinctive design.

Finishes: SNNP  
Matching WC Turn: MWCSNNP  
Matching Key Esc: MESCKSNNP  
Matching Euro Esc: MESCESNNP  
Matching Latch: AL3SN

Base Material: Zinc Alloy  
Dimensions:  
A: 51mm B: 131mm C: 10mm D: 61mm

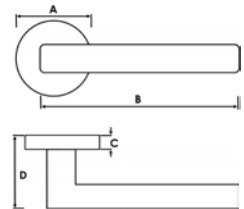

# PALERMO

*Designer Lever Door Handle*

LEVER ON ROSE - ROUND ROSE



Satin Nickel / Nickel Plate  
(SNNP)

**M63SNNP PALERMO LEVER ON ROUND ROSE**  
A bold and modern lever design

Finishes: SNNP  
Matching WC Turn: MWCSNNP  
Matching Key Esc: MESCKSNNP  
Matching Euro Esc: MESCESNNP  
Matching Latch: AL3SN

Base Material: Zinc Alloy  
Dimensions:  
A: 51mm B: 124mm C: 10mm D: 70mm

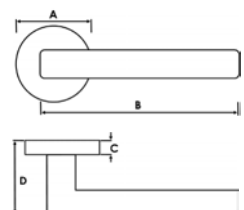

# IBIZA

*Designer Lever Door Handle*

LEVER ON ROSE - ROUND ROSE



Satin Nickel / Nickel Plate  
(SNNP)

**M46SNNP IBIZA LEVER ON ROUND ROSE**  
A unique, statement lever design.

Finishes: SNNP  
Matching WC Turn: MWCSNNP  
Matching Key Esc: MESCKSNNP  
Matching Euro Esc: MESCESNNP  
Matching Latch: AL3SN

Base Material: Zinc Alloy  
Dimensions:  
A: 51mm B: 133mm C: 10mm D: 67mm

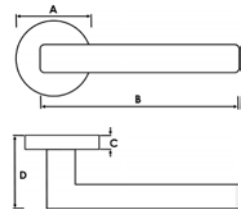

# ANCON

*Designer Lever Door Handle*

LEVER ON ROSE - ROUND ROSE

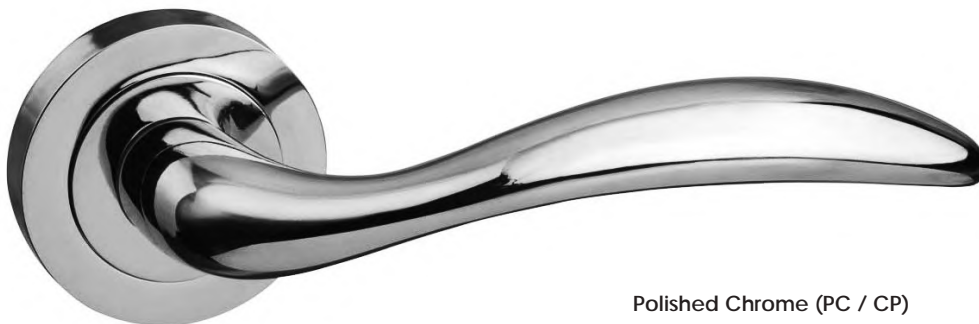

Polished Chrome (PC / CP)

**M77CP ANCON LEVER ON ROUND ROSE**  
A curved design that feels beautiful when held.

Finishes: PC(CP)  
Matching WC Turn: MWCCP  
Matching Key Esc: MESCKCP  
Matching Euro Esc: MESCECP  
Matching Latch: AL3PC

Base Material: Zinc Alloy  
Dimensions:  
A: 51mm B: 135mm C: 10mm D: 64mm

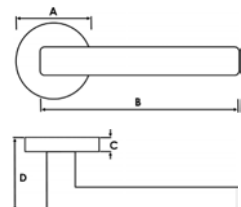

# ORAN

*Designer Lever Door Handle*

LEVER ON ROSE - ROUND ROSE



Satin Nickel / Polished  
Chrome (SNCP)

**M73SNCP ORAN LEVER ON ROUND ROSE**  
Oran showcases an intricate design in a dual finish.

Finishes: SNCP  
Matching WC Turn: MWCSNCP  
Matching Key Esc: MESCKSNCP  
Matching Euro Esc: MESCESNCP  
Matching Latch: AL3SN

Base Material: Zinc Alloy  
Dimensions:  
A: 51mm B: 136mm C: 10mm D: 65mm

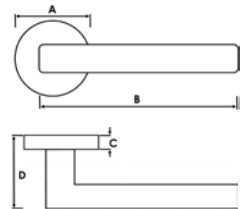

# MONACO

*Designer Lever Door Handle*

LEVER ON ROSE - ROUND ROSE



Satin Nickel / Polished  
Chrome (SNCP)

**M78SNCP MONACO LEVER ON ROUND ROSE**  
A bold and striking lever that is bound to make a statement.

Finishes: SNCP  
Matching WC Turn: MWCSNCP  
Matching Key Esc: MESCKSNCP  
Matching Euro Esc: MESCESNCP  
Matching Latch: AL3SN

Base Material: Zinc Alloy  
Dimensions:  
A: 51mm B: 136mm C: 10mm D: 71mm

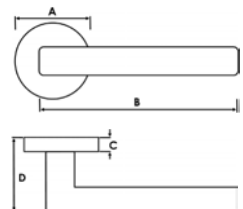



# TUNIS

## *Designer Lever Door Handle*

LEVER ON ROSE - ROUND ROSE



Satin Nickel / Polished Chrome (SNCP)

### **M125SNCP TUNIS LEVER ON ROUND ROSE**

The combination of dual finish creates a warm, modern finish option.

Finishes: SNCP  
Matching WC Turn: MWCSNCP  
Matching Key Esc: MESCKSNCP  
Matching Euro Esc: MESCESNCP  
Matching Latch: AL3SN

Base Material: Zinc Alloy  
Dimensions:  
A: 51mm B: 125mm C: 10mm D: 64mm

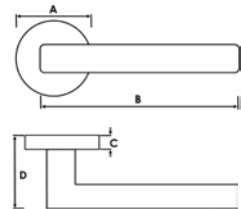

# TOULON

## *Designer Lever Door Handle*

LEVER ON ROSE - ROUND ROSE



Satin Nickel / Polished Chrome (SNCP)

### **M191SNCP TOULON LEVER ON ROUND ROSE**

A contemporary, streamlined design that feels modern and distinctive.

Finishes: SNCP  
Matching WC Turn: MWCSNCP  
Matching Key Esc: MESCKSNCP  
Matching Euro Esc: MESCESNCP  
Matching Latch: AL3SN

Base Material: Zinc Alloy  
Dimensions:  
A: 51mm B: 140mm C: 10mm D: 58mm

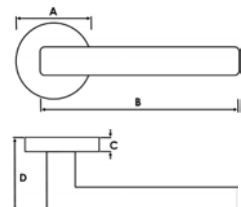



# SANTORINI

*Designer Lever Door Handle*  
LEVER ON ROSE - ROUND ROSE



Satin Chrome / Polished  
Chrome (SCPC)

**M90SCPC SANTORINI LEVER ON ROUND ROSE**  
A chic, modern design with a streamline feel.

Other Finishes: SCPC  
Matching WC Turn: MWCSCPC  
Matching Key Esc: MESCKSCPC  
Matching Euro Esc: MESCESPC  
Matching Latch: AL3PC

Base Material: Zinc Alloy  
Dimensions:  
A: 50mm B: 122mm C: 10mm D: 65mm

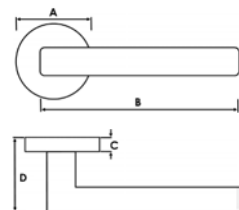

# ACCESSORIES

## ESCUTCHEONS | WC TURN & RELEASE



SN



### MESCK(finish) KEY ESCUTCHEON ROUND

Finishes: BP, CP, SCPC, SN, SNCP, SNNP  
Base Material: Zinc Alloy  
Sold with matching wood screws.

Dimensions: Width/Height: 51mm Depth: 10mm  
Unit: Sold in Pairs



SN



### MCESCK(finish) KEY ESCUTCHEON ON 'C' ROUND

Finishes: PC, SN  
Base Material: Zinc Alloy  
Sold with matching wood screws.

Dimensions: Width/Height: 51mm Depth: 10mm  
Unit: Sold in Pairs



SN



### MESCE(finish) EURO ESCUTCHEON ROUND

Finishes: BP, CP, SCPC, SN, SNCP, SNNP  
Base Material: Zinc Alloy  
Sold with matching wood screws.

Dimensions: Width/Height: 51mm Depth: 10mm  
Unit: Sold in Pairs



SN



### MCESCE(finish) EURO ESCUTCHEON ON 'C' ROUND

Finishes: PC, SN  
Base Material: Zinc Alloy  
Sold with matching wood screws.

Dimensions: Width/Height: 51mm Depth: 10mm  
Unit: Sold in Pairs



SN



### MWC(finish) WC TURN & RELEASE ROUND

Finishes: BP, CP, SCPC, SN, SNCP, SNNP  
Base Material: Zinc Alloy  
Sold with matching wood screws.

Dimensions: Width/Height: 51mm Depth: 10mm  
Projection: 25mm



SN



### MCWC(finish) WC TURN & RELEASE ON 'C' ROUND

Finishes: CP, SN  
Base Material: Zinc Alloy  
Sold with matching wood screws.

Dimensions: Rose Width/Height: 51mm Depth: 10mm  
Projection: 25mm

# STATUS<sup>®</sup>

Effortlessly chic, our Status range showcases contemporary stylish designs. Offering exceptional value without compromising on quality, our Status collection is the perfect blend of style and affordability.

With finishes that include the timeless Satin Nickel and the striking Black Nickel, Status combines sophistication with boldness, making it an ideal choice for modern interiors.



STATUS SQUARE ROSE  
EURO ESCUTCHEON -  
BLACK NICKEL



STATUS SQUARE ROSE  
WC TURN & RELEASE -  
BLACK NICKEL



STATUS OKLAHOMA  
LEVER - BLACK NICKEL



STATUS MONTANA  
LEVER - MATT BLACK



STATUS SQUARE ROSE  
EURO ESCUTCHEON -  
MATT BLACK

STATUS SQUARE ROSE  
WC TURN & RELEASE -  
MATT BLACK

Our Status collection is all about modern and bold designs. Featuring a range of on-trend finishes, this collection is a favourite among homeowners and designers alike. With its streamlined designs, Status delivers striking statement pieces that enhance any space.

# STATUS®



# COLORADO

*Designer Lever Door Handle*

LEVER ON ROSE - ROUND ROSE

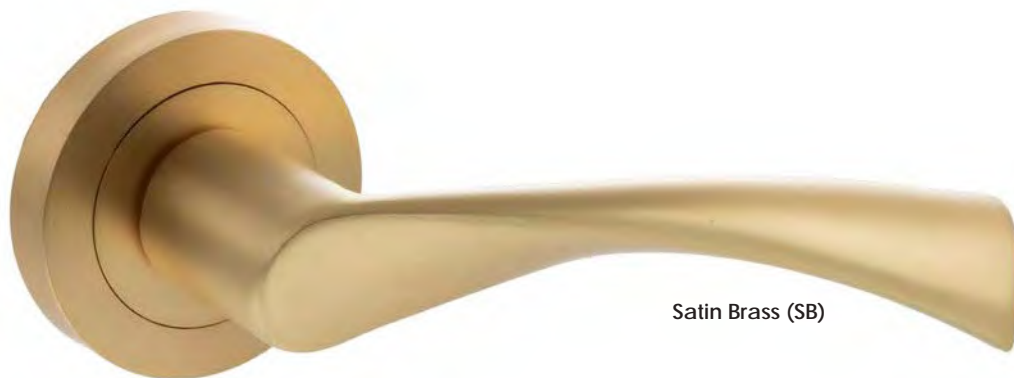

Satin Brass (SB)

**S34R(finish) COLORADO LEVER ON ROUND ROSE**

Sleek and modern, a classic design for any interior.

Finishes: AB, BN, MB, PC, SB, SC, SN, UDB  
 Matching WC Turn: S2WCR(finish)  
 Matching Key Esc: S2ESCKR(finish)  
 Matching Euro Esc: S2ESCER(finish)  
 Matching Latch: AL3(finish)

Base Material: Zinc Alloy  
 Dimensions:  
 A: 51mm B: 124mm C: 10mm D: 70mm

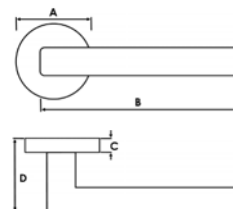

## FINISHES:



ANTIQUÉ BRASS (AB)



BLACK NICKEL (BN)



MATT BLACK (MB)



POLISHED CHROME (PC)



SATIN BRASS (SB)



SATIN CHROME (SC)



SATIN NICKEL (SN)



URBAN DARK BRONZE (UDB)





# TEXAS

*Designer Lever Door Handle*

LEVER ON ROSE - ROUND ROSE



Antique Brass (AB)

**S35R(finish) TEXAS LEVER ON ROUND ROSE**  
A timeless and classic design.

Finishes: AB, BN, MB, PC, SB, SC, UDB  
Matching WC Turn: S2WCR(finish)  
Matching Key Esc: S2ESCKR(finish)  
Matching Euro Esc: S2ESCER(finish)  
Matching Latch: AL3(finish)

Base Material: Zinc Alloy  
Dimensions:  
A: 51mm B: 118mm C: 10mm D: 61mm

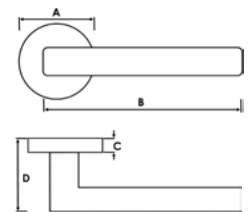

## FINISHES:



ANTIQUÉ BRASS (AB)



BLACK NICKEL (BN)



MATT BLACK (MB)



POLISHED CHROME (PC)



SATIN BRASS (SB)



SATIN CHROME (SC)



URBAN DARK BRONZE (UDB)



# INDIANA

*Designer Lever Door Handle*

LEVER ON ROSE - ROUND ROSE



Satin Nickel Brass Plated (SNBP)

## S33R(finish) INDIANA LEVER ON ROUND ROSE

An eye-catching and contemporary design.

Finishes: AB, MB, SB, SCPC, SNBP, UDB  
 Matching WC Turn: S3WCR(dual finish)  
 S2WCR(single finish)  
 Matching Key Esc: S3ESCKR(dual finish)  
 S2ESCKR(single finish)

Matching Euro Esc: S3ESCER(dual finish)  
 S2ESCER(single finish)  
 Matching Latch: AL3(finish)  
 Base Material: Zinc Alloy  
 Dimensions:  
 A: 51mm B: 126mm C: 10mm D: 61mm

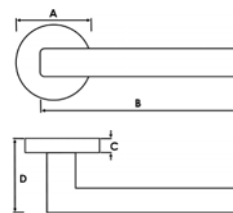

## FINISHES:



ANTIQUE BRASS (AB)



MATT BLACK (MB)



SATIN BRASS (SB)



SATIN CHROME POLISHED CHROME (SCPC)



SATIN NICKEL BRASS PLATED (SNBP)



URBAN DARK BRONZE (UDB)

# CAROLINA

*Designer Lever Door Handle*

LEVER ON ROSE - ROUND ROSE



Urban Dark Bronze (UDB)

**S42R(finish) CAROLINA LEVER ON ROUND ROSE**  
An elegant design that feels luxurious and modern.

Finishes: AB, MB, PC, SB, SN, UDB  
Matching WC Turn: S2WCR(finish)  
Matching Key Esc: S2ESCKR(finish)  
Matching Euro Esc: S2ESCER(finish)  
Matching Latch: AL3(finish)

Base Material: Zinc Alloy  
Dimensions:  
A: 50mm B: 122mm C: 10mm D: 57mm

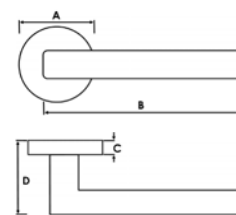

## FINISHES:



ANTIQUE BRASS (AB)



MATT BLACK (MB)



POLISHED CHROME (PC)



SATIN BRASS (SB)



SATIN NICKEL (SN)



URBAN DARK BRONZE (UDB)

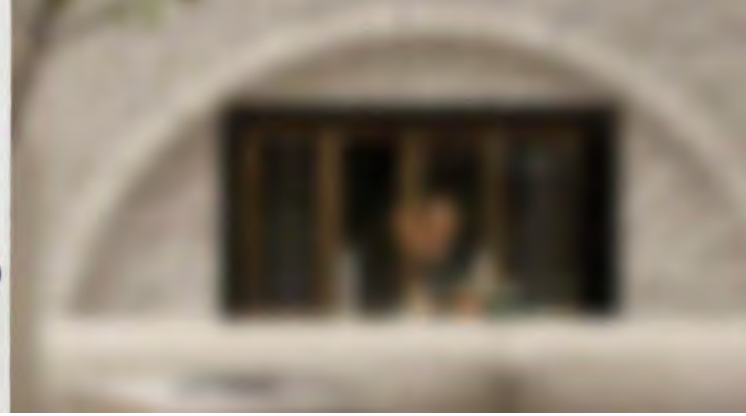

# ALABAMA

*Designer Lever Door Handle*

LEVER ON ROSE - ROUND ROSE

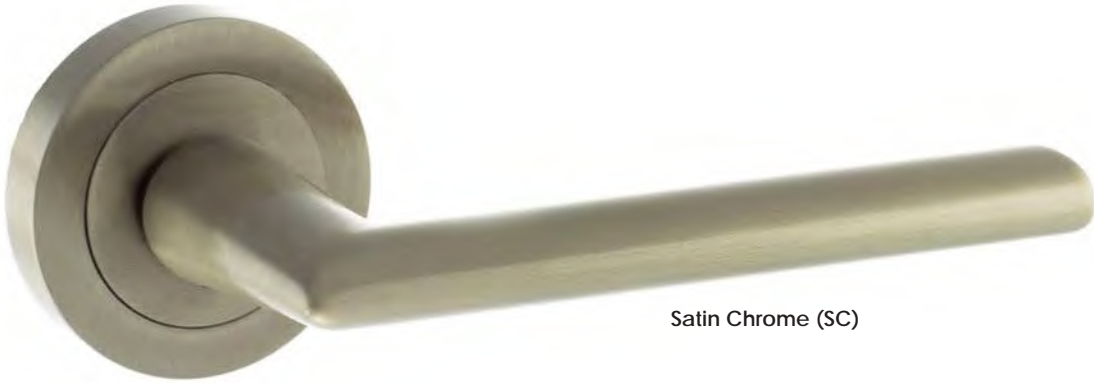

Satin Chrome (SC)

**S43R(finish) ALABAMA LEVER ON ROUND ROSE**

A modern look that is timeless and sleek.

Finishes: AB, MB, PC, SB, SC, UDB  
 Matching WC Turn: S2WCR(finish)  
 Matching Key Esc: S2ESCKR(finish)  
 Matching Euro Esc: S2ESCER(finish)  
 Matching Latch: AL3(finish)

Base Material: Zinc Alloy  
 Dimensions:  
 A: 50mm B: 117mm C: 10mm D: 64mm

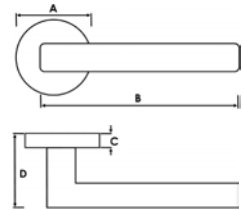

## FINISHES:



ANTIQUE BRASS (AB)



MATT BLACK (MB)



POLISHED CHROME (PC)



SATIN BRASS (SB)



SATIN CHROME (SC)



URBAN DARK BRONZE (UDB)

# NEBRASKA

*Designer Lever Door Handle*

LEVER ON ROSE - ROUND ROSE

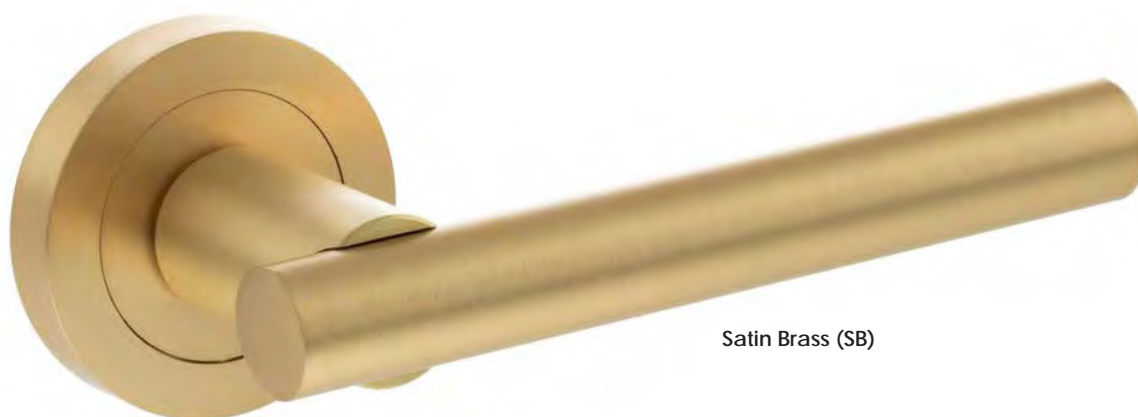

Satin Brass (SB)

**S28R(finish) NEBRASKA LEVER ON ROUND ROSE**  
A contemporary design, perfect for any modern interior.

Finishes: AB, MB, PC, SB, SC, UDB  
Matching WC Turn: S2WCR(finish)  
Matching Key Esc: S2ESCKR(finish)  
Matching Euro Esc: S2ESCER(finish)  
Matching Latch: AL3(finish)

Base Material: Zinc Alloy  
Dimensions:  
A: 52mm B: 126mm C: 10mm D: 62mm

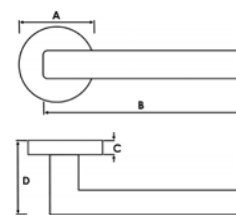

## FINISHES:



ANTIQUE BRASS (AB)



MATT BLACK (MB)



POLISHED CHROME (PC)



SATIN BRASS (SB)



SATIN CHROME (SC)



URBAN DARK BRONZE (UDB)

# NEVADA

*Designer Lever Door Handle*

LEVER ON ROSE - ROUND ROSE

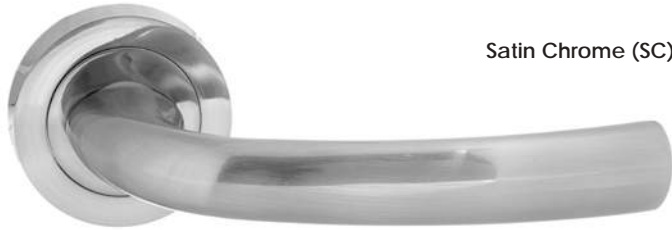

Satin Chrome (SC)

**S21R(finish) NEVADA LEVER ON ROUND ROSE**  
A curved lever design that looks timelessly glamorous.

Finishes: PC, SC  
Matching WC Turn: S2WCR(finish)  
Matching Key Esc: S2ESCKR(finish)  
Matching Euro Esc: S2ESCER(finish)  
Matching Latch: AL3(finish)

Base Material: Zinc Alloy  
Dimensions:  
A: 51mm B: 130mm C: 10mm D: 60mm

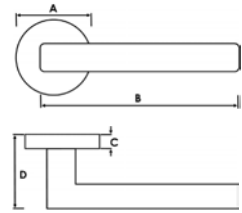

## FINISHES:



POLISHED CHROME (PC)



SATIN CHROME (SC)

# ARIZONA

*Designer Lever Door Handle*

LEVER ON ROSE - ROUND ROSE



Satin Chrome (SC)

**S22R(finish) ARIZONA LEVER ON ROUND ROSE**  
Arizona features an understated curved design.

Finishes: PC, SC  
Matching WC Turn: S2WCR(finish)  
Matching Key Esc: S2ESCKR(finish)  
Matching Euro Esc: S2ESCER(finish)  
Matching Latch: AL3(finish)

Base Material: Zinc Alloy  
Dimensions:  
A: 51mm B: 125mm C: 10mm D: 52mm

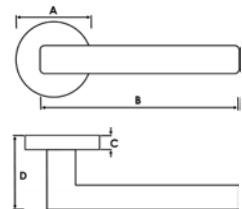

## FINISHES:



POLISHED CHROME (PC)



SATIN CHROME (SC)

# FLORIDA

*Designer Lever Door Handle*

LEVER ON ROSE - ROUND ROSE



Satin Chrome / Polished Chrome (SCPC)

**S32RSCPC FLORIDA LEVER ON ROUND ROSE**  
Florida features a gentle curved effect to the lever.

Finishes: SCPC  
Matching WC Turn: S3WCRSCPC  
Matching Key Esc: S3ESCKRSCPC  
Matching Euro Esc: S3ESCERSPC  
Matching Latch: AL3SC

Base Material: Zinc Alloy  
Dimensions:  
A: 51mm B: 122mm C: 10mm D: 61mm

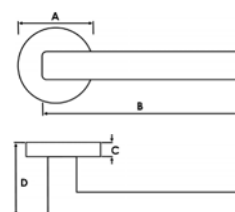

# DAKOTA

*Designer Lever Door Handle*

LEVER ON ROSE - ROUND ROSE



Satin Chrome Polished Chrome (SCPC)

**S36R(finish) DAKOTA LEVER ON ROUND ROSE**  
A statement lever with bold design details.

Other Finishes: BNPC, SCPC  
Matching WC Turn: S3WCR(finish)  
Matching Key Esc: S3ESCKR(finish)  
Matching Euro Esc: S3ESCER(finish)  
Matching Latch: AL3(finish)

Base Material: Zinc Alloy  
Dimensions:  
A: 51mm B: 139mm C: 10mm D: 59mm

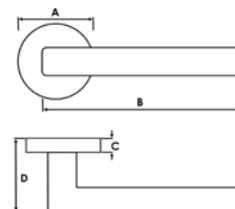

## FINISHES:



BLACK NICKEL POLISHED CHROME (BNPC)



SATIN CHROME POLISHED CHROME (SCPC)

# HAWAII

*Designer Lever Door Handle*

LEVER ON ROSE - ROUND ROSE



Satin Chrome / Polished Chrome (SCPC)

## S38RSCPC HAWAII LEVER ON ROUND ROSE

Stylish and elegant, a perfect lever for any modern space.

Finishes: SCPC  
Matching WC Turn: S3WCRSCPC  
Matching Key Esc: S3ESCKRSCPC  
Matching Euro Esc: S3ESCERSCPC  
Matching Latch: AL3SC

Base Material: Zinc Alloy  
Dimensions:  
A: 51mm B: 130mm C: 10mm D: 60mm

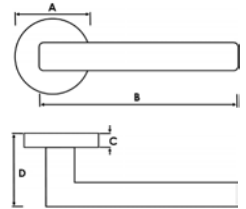

# ALASKA

*Designer Lever Door Handle*

LEVER ON ROSE - ROUND ROSE



Matt Black (MB)

## S26RMB ALASKA LEVER ON ROUND ROSE

An understated, yet bold designer handle.

Finishes: MB  
Matching WC Turn: S2WCRMB  
Matching Key Esc: S2ESCKRMB  
Matching Euro Esc: S2ESCERMB  
Matching Latch: AL3MB

Base Material: Zinc Alloy  
Dimensions:  
A: 52mm B: 128mm C: 10mm D: 67mm

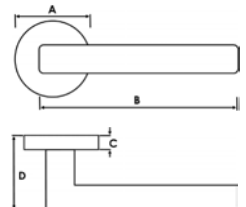



# TENNESSEE

*Designer Lever Door Handle*

LEVER ON ROSE - ROUND ROSE



Black Nickel / Polished Chrome (BNPC)

**S37RBNPC TENNESSEE LEVER ON ROUND ROSE**  
A sleek and modern lever design.

Finishes: BNPC  
Matching WC Turn: S3WCRBNPC  
Matching Key Esc: S3ESCKRBNPC  
Matching Euro Esc: S3ESCERBNPC  
Matching Latch: AL3PC

Base Material: Zinc Alloy  
Dimensions:  
A: 51mm B: 138mm C: 10mm D: 56mm

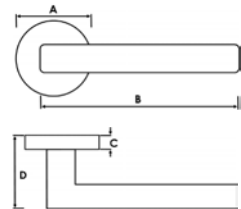

# OKLAHOMA

*Designer Lever Door Handle*

LEVER ON ROSE - SQUARE ROSE



Black Nickel (BN)

**S25SBN OKLAHOMA LEVER ON SQUARE ROSE**  
A bold and contemporary lever design.

Finishes: BN  
Matching WC Turn: S2WCSBN  
Matching Key Esc: S2ESCKSBN  
Matching Euro Esc: S2ESCESBN  
Matching Latch: AL3BN

Base Material: Zinc Alloy  
Dimensions:  
A: 52mm B: 131mm C: 10mm D: 57mm

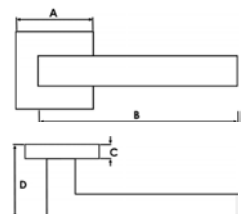



# MONTANA

*Designer Lever Door Handle*

LEVER ON ROSE - SQUARE ROSE

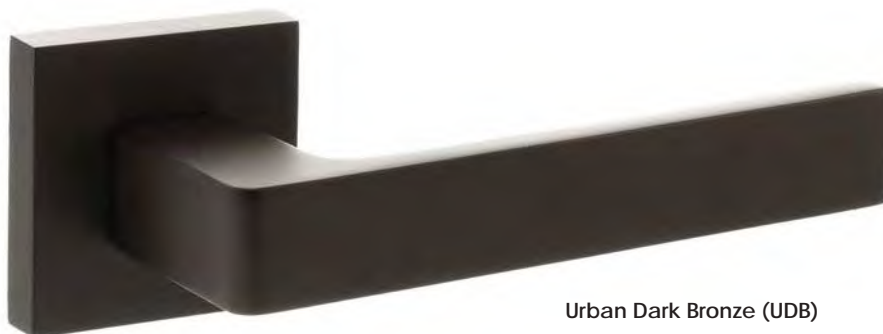

Urban Dark Bronze (UDB)

**S40S(finish) MONTANA LEVER ON SQUARE ROSE**

A perfect minimalist statement for any door.

Other Finishes: AB, MB, PC, SB, SC, SN, SNPC, UDB  
 Matching WC Turn: S4WCS(finish)  
 Matching Key Esc: S4ESCKS(finish)  
 Matching Euro Esc: S4ESCES(finish)  
 Matching Latch: AL3(finish)

Base Material: Zinc Alloy  
 Dimensions:  
 A: 50.5mm B: 128mm C: 10mm D: 53mm

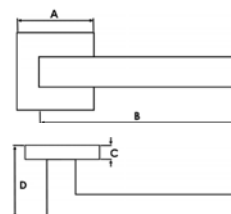

## FINISHES:



ANTIQUE BRASS (AB)



MATT BLACK (MB)



POLISHED CHROME (PC)



SATIN BRASS (SB)



SATIN CHROME (SC)



SATIN NICKEL (SN)



SATIN NICKEL POLISHED CHROME (SNPC)



URBAN DARK BRONZE (UDB)

# KANSAS

*Designer Lever Door Handle*

LEVER ON ROSE - SQUARE ROSE



Black Nickel (BN)

## S24S(finish) KANSAS LEVER ON SQUARE ROSE

A classic square rose design with a modern, bold feel.

Other Finishes: BN, PC, SC  
 Matching WC Turn: S2WCS(finish)  
 Matching Key Esc: S2ESCKS(finish)  
 Matching Euro Esc: S2ESCES(finish)  
 Matching Latch: AL3(finish)

Base Material: Zinc Alloy  
 Dimensions:  
 A: 51mm B: 133mm C: 10mm D: 47mm

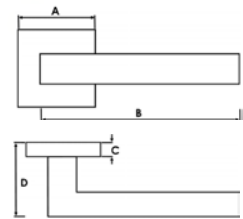

## FINISHES:



BLACK NICKEL (BN)



POLISHED CHROME (PC)



SATIN CHROME (SC)

# CALIFORNIA

*Designer Lever Door Handle*

LEVER ON ROSE - SQUARE ROSE



Satin Chrome (SC)

## S23SSC CALIFORNIA LEVER ON SQUARE ROSE

A modern, angular lever that is perfect for making a statement.

Finishes: SC  
 Matching WC Turn: S2WCSSC  
 Matching Key Esc: S2ESCKSSC  
 Matching Euro Esc: S2ESCESSC  
 Matching Latch: AL3SC

Base Material: Zinc Alloy  
 Dimensions:  
 A: 51mm B: 132mm C: 10mm D: 61mm

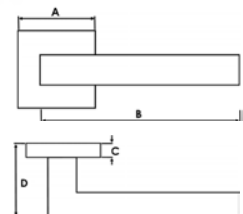

# ACCESSORIES

## ESCUTCHEONS | WC TURN & RELEASE



SC



### S2ESCKR(finish) KEY ESCUTCHEON ROUND

Finishes: AB, BN, MB, PC, SB, SC, SN, UDB  
 Also Available: S3ESCKR(finish) SCPC, SNBP, BNPC  
 Base Material: Zinc Alloy  
 Sold with matching wood screws.  
 Dimensions: Width/Height: 51mm Depth: 10mm  
 Unit: Sold in Pairs



SNBP



### S3ESCKR(finish) KEY ESCUTCHEON ROUND

Finishes: BNPC, SCPC, SNBP  
 Also Available: S2ESCKR(finish) AB, BN, MB, PC, SB, SC, SN, UDB  
 Base Material: Zinc Alloy  
 Sold with matching wood screws.  
 Dimensions: Width/Height: 51mm Depth: 10mm  
 Unit: Sold in Pairs



SC



### S2ESCER(finish) EURO ESCUTCHEON ROUND

Finishes: AB, BN, MB, PC, SB, SC, SN, UDB  
 Also Available: S3ESCER(finish) SCPC, SNBP, BNPC  
 Base Material: Zinc Alloy  
 Sold with matching wood screws.  
 Dimensions: Width/Height: 51mm Depth: 10mm  
 Unit: Sold in Pairs



BNPC



### S3ESCER(finish) EURO ESCUTCHEON ROUND

Finishes: BNPC, SCPC, SNBP  
 Also Available: S2ESCER(finish) AB, BN, MB, PC, SB, SC, SN, UDB  
 Base Material: Zinc Alloy  
 Sold with matching wood screws.  
 Dimensions: Width/Height: 51mm Depth: 10mm  
 Unit: Sold in Pairs



SC



### S2ESCKS(finish) KEY ESCUTCHEON SQUARE

Finishes: BN, PC, SC  
 Base Material: Zinc Alloy  
 Sold with matching wood screws.  
 Dimensions: Width/Height: 51mm Depth: 10mm  
 Unit: Sold in Pairs



SC



### S2ESCES(finish) EURO ESCUTCHEON SQUARE

Finishes: BN, PC, SC  
 Base Material: Zinc Alloy  
 Sold with matching wood screws.  
 Dimensions: Width/Height: 51mm Depth: 10mm  
 Unit: Sold in Pairs



SN



### S4ESCKS(finish) KEY ESCUTCHEON SQUARE

Finishes: PC, SC, SN, SNPC  
 Also Available (pg 149): AB, MB, SB, UDB  
 Base Material: Zinc Alloy  
 Sold with matching wood screws.  
 Dimensions: Width/Height: 51mm Depth: 10mm  
 Unit: Sold in Pairs



SN



### S4ESCES(finish) EURO ESCUTCHEON SQUARE

Finishes: PC, SC, SN, SNPC  
 Also Available (pg 149): AB, MB, SB, UDB  
 Base Material: Zinc Alloy  
 Sold with matching wood screws.  
 Dimensions: Width/Height: 51mm Depth: 10mm  
 Unit: Sold in Pairs

# ACCESSORIES

## ESCUTCHEONS | WC TURN & RELEASE



MB



### S4ESCKS(finish) KEY ESCUTCHEON SQUARE

Finishes: AB, MB, SB, UDB  
Base Material: Zinc Alloy  
Sold with matching wood screws.  
Dimensions: Width/Height: 51mm Depth: 10mm  
Unit: Sold in Pairs



MB



### S4ESCES(finish) EURO ESCUTCHEON SQUARE

Finishes: AB, MB, SB, UDB  
Base Material: Zinc Alloy  
Sold with matching wood screws.  
Dimensions: Width/Height: 51mm Depth: 10mm  
Unit: Sold in Pairs



SC



### S2WCR(finish) WC TURN & RELEASE ROUND

Finishes: AB, BN, MB, PC, SB, SC, SN, UDB  
Also Available: S3WCR (finish) BNPC, SCPC, SNBP  
Base Material: Zinc Alloy  
Sold with matching wood screws.  
Dimensions: Width/Height: 51mm Depth: 10mm  
Projection: 40mm



SCPC



### S3WCR(finish) WC TURN & RELEASE ROUND

Finishes: BNPC, SCPC, SNBP  
Also Available: S2WCR(finish) AB, BN, MB, PC, SB, SC, SN, UDB  
Base Material: Zinc Alloy  
Sold with matching wood screws.  
Dimensions: Width/Height: 51mm Depth: 10mm  
Projection: 40mm



SC



### S2WCS(finish) WC TURN & RELEASE SQUARE

Finishes: BN, PC, SC  
Base Material: Zinc Alloy  
Sold with matching wood screws.  
Dimensions: Rose Width/Height: 51mm Depth: 10mm  
Projection: 40mm



SN



### S4WCS(finish) WC TURN & RELEASE SQUARE

Finishes: PC, SC, SN, SNPC  
Also Available: AB, MB, SB, UDB  
Base Material: Zinc Alloy  
Sold with matching wood screws.  
Dimensions: Rose Width/Height: 51mm Depth: 10mm  
Projection: 45mm



MB

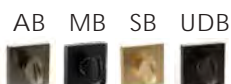

### S4WCS(finish) WC TURN & RELEASE SQUARE

Finishes: AB, MB, SB, UDB  
Base Material: Zinc Alloy  
Sold with matching wood screws.  
Dimensions: Rose Width/Height: 51mm Depth: 10mm  
Projection: 40mm



# CleanTouch

antibacterial protection

Antibacterial protection does not need to look clinical and colourless...It can be designer, stylish and bold! 99% cleaner than unprotected surfaces, CleanTouch offers a hospital-level of hygiene in trending finishes & designs.

Scientifically proven through certified lab results, the anti-bacterial treatment used to coat these products ensures total elimination of bacteria.

Guaranteeing the protection of people within their environment, it reduces the risk of bacteria spreading. Using a non-toxic finishing treatment (unlike other anti-bacterial powder varnishes) it creates a safer space for people to live and work in.



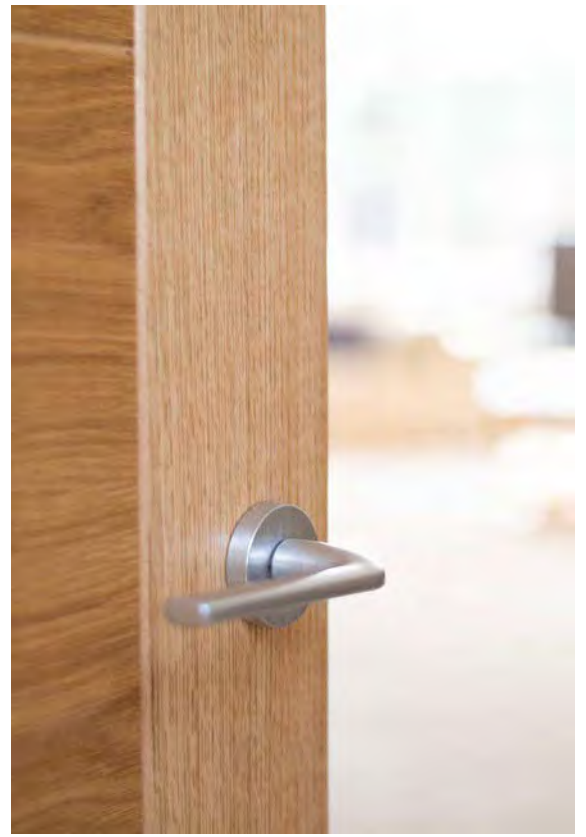

All of our Forme products in the **Matt Black** finish are now coated with our CleanTouch antibacterial protection, so you can be sure your door hardware is stylish and safe!

*Explore the full range on page 52-70*

forme



# SPECIAL ORDER

We currently offer a selection of our Forme range in a Satin Chrome finish with CleanTouch as special order items. All of our Forme products in the Matt Black finish are now coated with our CleanTouch antibacterial protection as standard. **Explore the full range on page 52-70**

## MILLY

LEVER ON ROSE - ROUND ROSE | [ANTI-BACTERIAL DESIGNER LEVERS](#)



Satin Chrome (SC)

**CTFMR133SC MILLY LEVER ON ROUND ROSE WITH ANTI-BACTERIAL COATING**  
An understated, minimalistic design.

Finishes: SC  
Matching WC Turn: CTFMRWCSC  
Matching Key Esc: CTFMRKSC  
Matching Euro Esc: CTFMRESC  
Matching Latch: AL3SC  
Base Material: Zamak

Dimensions:  
A: 50mm B: 128mm C: 10mm D: 63mm  
In the CleanTouch Range, Forme Levers are distinguished by the CleanTouch logo on lever neck.

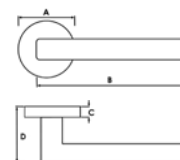

## ASTI

LEVER ON ROSE - ROUND & SQUARE ROSE | [ANTI-BACTERIAL DESIGNER LEVERS](#)



Satin Chrome (SC)

**CTFMR254SC ASTI LEVER ON ROUND ROSE WITH ANTI-BACTERIAL COATING**  
A stylish, modern design.

Finishes: SC  
Matching WC Turn: CTFMRWCSC  
Matching Key Esc: CTFMRKSC  
Matching Euro Esc: CTFMRESC  
Matching Latch: AL3SC  
Base Material: Zamak

Dimensions:  
A: 50mm B: 129mm C: 10mm D: 56mm  
In the CleanTouch Range, Forme Levers are distinguished by the CleanTouch logo on lever neck.

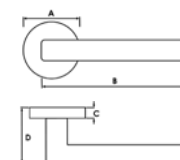

Satin Chrome (SC)

**CTFMS254SC ASTI LEVER ON SQUARE ROSE WITH ANTI-BACTERIAL COATING**  
A contemporary, sleek lever design.

Finishes: SC  
Matching WC Turn: CTFMSWCSC  
Matching Key Esc: CTFMSKSC  
Matching Euro Esc: CTFMSESC  
Matching Latch: AL3SC  
Base Material: Zamak

Dimensions:  
A: 50mm B: 129mm C: 10mm D: 56mm  
In the CleanTouch Range, Forme Levers are distinguished by the CleanTouch logo on lever neck.

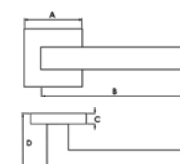

### Forme WC Turn & Release with Anti-Bacterial Coating - Satin Chrome

CTFMSWCSC - Square Rose  
CTFMRWCSC - Round Rose

### Forme Escutcheon with Anti-Bacterial Coating - Satin Chrome

CTFMESEC - Euro, Square Rose  
CTFMRESC - Euro, Round Rose  
CTFMSKSC - Key, Square Rose  
CTFMRKSC - Key, Round Rose



For dimensions please refer to page 70 as the Forme Accessories are the same size.



# SPECIAL ORDER

---

COMMERCIAL HARDWARE | [ANTI-BACTERIAL DESIGNER LEVERS](#)

As well as our standard Forme in Matt Black and special order Forme Satin Chrome products, we're also able to provide a selection of commercial hardware with our CleanTouch coating. Including a variety of Pull Handles, Levers and Finger Plates, get in touch to find out what we can offer!

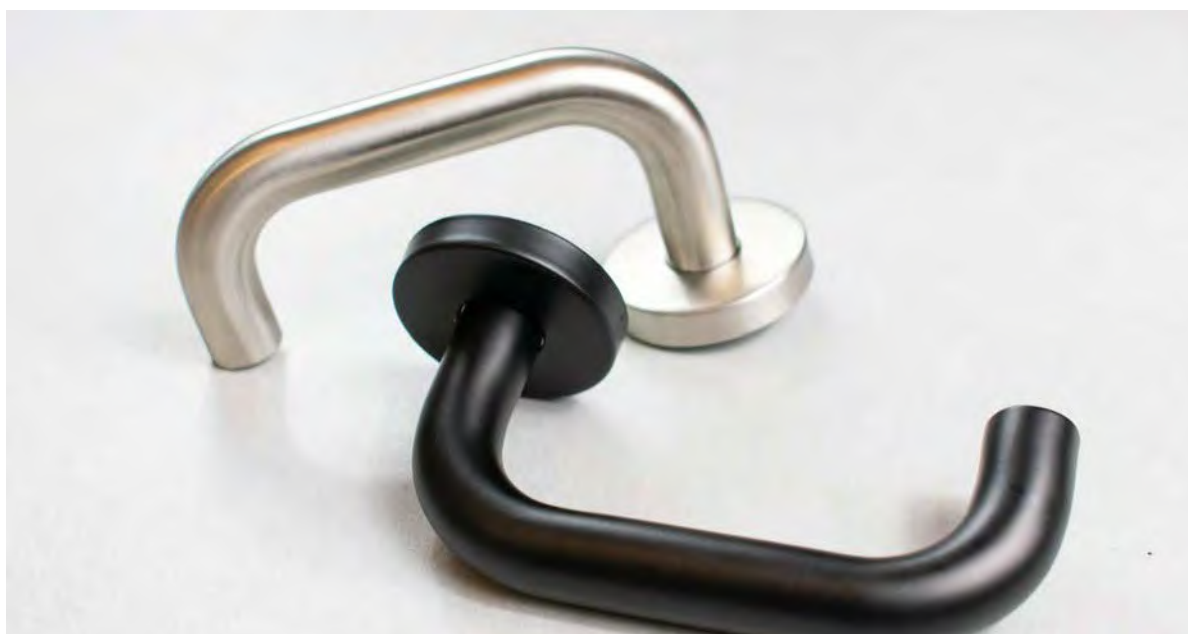





# CABINET HARDWARE

Our Cabinet Hardware collection features products from our **Millhouse Brass** and **Old English** collections. Available in a range of product styles, finishes and suites, there's something to suit every space.

# MILLHOUSE BRASS

---

## CABINET HARDWARE

Drawing inspiration from the architectural and design movements of the Industrial Revolution, as well as the Art Deco and Bauhaus periods, our latest Millhouse Brass launches are all named after iconic buildings of these prominent times.

The Industrial Revolution and these subsequent periods were marked by innovation, representing a time of transformative progress in industry, technology, and design. Millhouse Brass captures the essence of this industrial craftsmanship, blending it with a contemporary twist, making it an ideal choice for both modern and traditional interiors.

Inspired by the dynamic structures and intricate ironwork of renowned architectural landmarks, the collection features bold, modern designs with an emphasis on texture and finish.

Millhouse Brass embodies the innovative spirit and quality craftsmanship of these eras, delivering stunning, design-led products that are both stylish and timeless.



**PENNINGTON HEXAGONAL  
T-BAR CABINET KNOB -  
SATIN BRASS**

**PENNINGTON HEXAGONAL  
CABINET PULL HANDLE  
128MM - SATIN BRASS**



**PENNINGTON HEXAGONAL  
CYLINDER CABINET KNOB -  
SATIN BRASS**



**PENNINGTON HEXAGONAL  
CABINET PULL HANDLE  
160MM - SATIN BRASS**



**PENNINGTON HEXAGONAL  
FINGER PULL CABINET  
KNOB - SATIN BRASS**

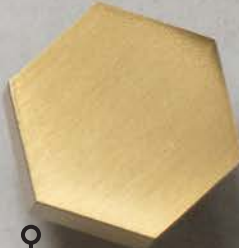

**PENNINGTON  
HEXAGONAL  
CABINET KNOB -  
SATIN BRASS**

**PENNINGTON HEXAGONAL  
CABINET PULL HANDLE  
320MM - SATIN BRASS**





# CABINET HARDWARE: TEXTURES



## KNURLED

Featuring a finely crafted, intricate pattern, our knurled texture brings an elevated tactile experience and a refined artisanal touch to any space.



## DIAMOND

With a unique diamond cut texture, it adds a glamorous and luxurious edge to an interior, perfect for creating a sophisticated space.

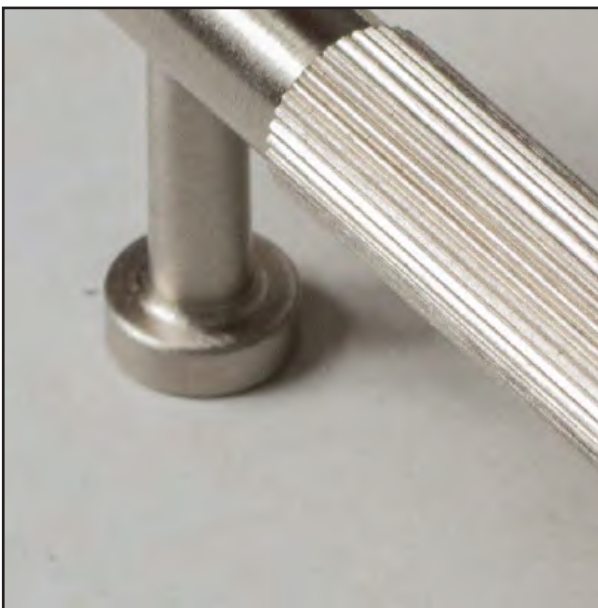

## LINEAR

A contemporary take on traditional knurling, our linear texture is modern and sleek.

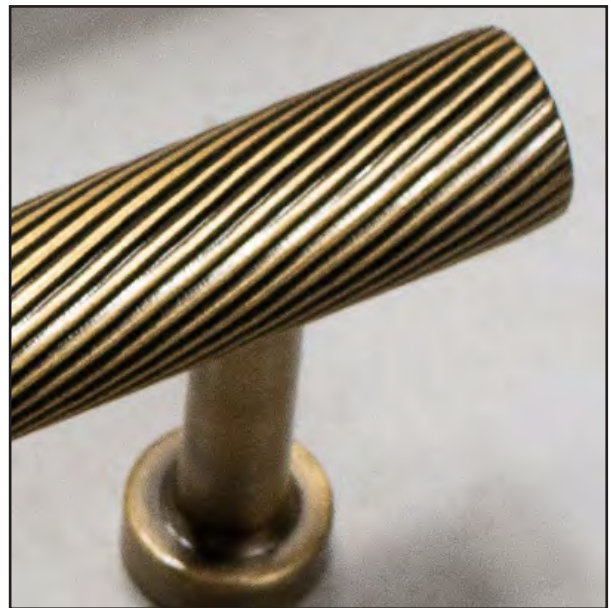

## SPIRAL

Perfect for creating a bold, striking statement, our spiral texture offers a modern alternative to classic knurling.

MILLHOUSE BRASS

CABINET HARDWARE

# EIFFEL

## Cabinet Hardware | KNURLED CYLINDER CABINET KNOBS

**MHCK1420(finish) EIFFEL** KNURLED CYLINDER CABINET KNOB  
Intricate knurled details with a stunning textured finish. Use with our full range of Eiffel products for a complete coordinated look.

Finishes: AB, MB, PC, SB, SN, UDB  
Base Material: Solid Brass

Dimensions  
Knob Diameter: 20mm  
Projection: 25mm



Satin Brass (SB)

### FINISHES:



ANTIQUE BRASS (AB)



MATT BLACK (MB)



POLISHED CHROME (PC)



SATIN BRASS (SB)



SATIN NICKEL (SN)



URBAN DARK BRONZE (UDB)

## Cabinet Hardware | KNURLED ROUND CABINET KNOBS

**MHCK1532(finish) EIFFEL** KNURLED ROUND CABINET KNOB  
Showcasing elegant knurled details in a classic round knob style. Pair with our round backplate (page 188) for a standout look.

Finishes: AB, MB, PC, SB, SN, UDB  
Base Material: Solid Brass

Dimensions  
Knob Diameter: 32mm  
Projection: 32mm  
Base Diameter: 12mm



Polished Chrome (PC)

### FINISHES:



ANTIQUE BRASS (AB)



MATT BLACK (MB)



POLISHED CHROME (PC)



SATIN BRASS (SB)



SATIN NICKEL (SN)



URBAN DARK BRONZE (UDB)

Recommended Backplate: MHCBR49(finish) Millhouse Round Backplate





# EIFFEL

## Cabinet Hardware | KNURLED FINGER PULL KNOBS

**MHCK1338(finish) EIFFEL** KNURLED FINGER PULL CABINET KNOB  
Tactile finger pull with stunning knurled details. Install horizontally or vertically. Pair with our full range of Eiffel products for a perfectly coordinated look.

Finishes: AB, MB, PC, SB, SN, UDB  
Base Material: Solid Brass

Dimensions  
Knob Diameter: 38mm  
Projection: 34mm  
Thickness: 9mm



Satin Brass (SB)

### FINISHES:

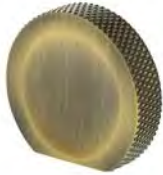

ANTIQUE BRASS (AB)



MATT BLACK (MB)



POLISHED CHROME (PC)



SATIN BRASS (SB)



SATIN NICKEL (SN)



URBAN DARK BRONZE (UDB)

## Cabinet Hardware | KNURLED SQUARE CABINET KNOBS

**MHCK1230(finish) EIFFEL** KNURLED SQUARE CABINET KNOB  
Featuring knurled details in a modern square knob style. Pair with our square backplate (page 188) for a statement look.

Finishes: AB, MB, PC, SB, SN, UDB  
Base Material: Solid Brass

Dimensions  
Knob Width / Length: 32mm  
Projection: 33mm  
Base Width/Length: 12mm



Antique Brass (AB)

### FINISHES:



ANTIQUE BRASS (AB)



MATT BLACK (MB)



POLISHED CHROME (PC)



SATIN BRASS (SB)



SATIN NICKEL (SN)



URBAN DARK BRONZE (UDB)

Recommended Backplate: MHCBS50(finish) Square Backplate

# EIFFEL

## Cabinet Hardware | KNURLED T-BAR CABINET KNOBS

**MHCK1675(finish) EIFFEL** KNURLED T-BAR CABINET KNOB  
 Stunning precise knurling in modern T-bar style. Use with our full range of Eiffel products for a complete coordinated look.

Finishes: AB, MB, PC, SB, SN, UDB  
 Base Material: Solid Brass

Dimensions  
 Length: 75mm  
 Knob Diameter: 13mm  
 Projection: 38mm



ANTIQUE BRASS (AB)

### FINISHES:



ANTIQUE BRASS (AB)



MATT BLACK (MB)



POLISHED CHROME (PC)



SATIN BRASS (SB)



SATIN NICKEL (SN)



URBAN DARK BRONZE (UDB)

## Cabinet Hardware | KNURLED T-BAR CABINET PULL HANDLE

**MHCK17128(finish) EIFFEL** KNURLED T-BAR CABINET PULL HANDLE 128MM  
 Exquisite knurled pull handles in three sizes. Option to pair with selection of backplates (page 185-187).

Finishes: AB, MB, PC, SB, SN, UDB  
 Base Material: Solid Brass

Dimensions  
 Centre to Centre: 128mm  
 Overall Length: 164mm  
 Projection from Door: 38mm

Recommended Backplate: MHCBW128(finish) Wide Cabinet Handle Backplate 128mm



Antique Brass (AB)

### FINISHES:



ANTIQUE BRASS (AB)



MATT BLACK (MB)



POLISHED CHROME (PC)



SATIN BRASS (SB)



SATIN NICKEL (SN)



URBAN DARK BRONZE (UDB)

# EIFFEL

## Cabinet Hardware | KNURLED T-BAR CABINET PULL HANDLE

**MHCK17160(finish) EIFFEL** KNURLED T-BAR CABINET PULL HANDLE 160MM  
Exquisite knurled pull handles in three sizes. Option to pair with selection of backplates (page 185-187).

Finishes: AB, MB, PC, SB, SN, UDB  
Base Material: Solid Brass

Dimensions  
Centre to Centre: 160mm  
Overall Length: 196mm  
Projection from Door: 38mm

Recommended Backplate: MHCBW160(finish) Wide Cabinet Handle Backplate 160mm



Matt Black (MB)

### FINISHES:



ANTIQUE BRASS (AB)



MATT BLACK (MB)



POLISHED CHROME (PC)



SATIN BRASS (SB)



SATIN NICKEL (SN)



URBAN DARK BRONZE (UDB)

## Cabinet Hardware | KNURLED T-BAR CABINET PULL HANDLE

**MHCK17320(finish) EIFFEL** KNURLED T-BAR CABINET PULL HANDLE 320MM  
Exquisite knurled pull handles in three sizes. Option to pair with selection of backplates (page 185-187).

Finishes: AB, MB, PC, SB, SN, UDB  
Base Material: Solid Brass

Dimensions  
Centre to Centre: 320mm  
Overall Length: 356mm  
Projection from Door: 38mm

Recommended Backplate: MHCBW320(finish) Wide Cabinet Handle Backplate 320mm



Satin Brass (SB)

### FINISHES:



ANTIQUE BRASS (AB)



MATT BLACK (MB)



POLISHED CHROME (PC)



SATIN BRASS (SB)



SATIN NICKEL (SN)



URBAN DARK BRONZE (UDB)

# BATTERSEA

## Cabinet Hardware | LINEAR CYLINDER CABINET KNOBS

**MHCL1420(finish) BATTERSEA** LINEAR CYLINDER CABINET KNOB  
With stunning linear details, Battersea adds a modern industrial touch to any interior.

Finishes: AB, MB, PC, SB, SN, UDB  
Base Material: Solid Brass

Dimensions  
Knob Diameter: 20mm  
Projection: 25mm



ANTIQUE BRASS (AB)

### FINISHES:



ANTIQUE BRASS (AB)



MATT BLACK (MB)



POLISHED CHROME (PC)



SATIN BRASS (SB)



SATIN NICKEL (SN)



URBAN DARK BRONZE (UDB)

## Cabinet Hardware | LINEAR ROUND CABINET KNOBS

**MHCL1532(finish) BATTERSEA** LINEAR ROUND CABINET KNOB  
Featuring modern linear details in a classic round knob style. Pair with our round backplate (page 188) for a standout look.

Finishes: AB, MB, PC, SB, SN, UDB  
Base Material: Solid Brass

Dimensions  
Knob Diameter: 32mm  
Projection: 32mm  
Base Diameter: 12mm



Urban Dark Bronze (UDB)

### FINISHES:



ANTIQUE BRASS (AB)



MATT BLACK (MB)



POLISHED CHROME (PC)



SATIN BRASS (SB)



SATIN NICKEL (SN)



URBAN DARK BRONZE (UDB)

# BATTERSEA

## Cabinet Hardware | LINEAR FINGER PULL KNOBS

**MHCL1338(finish) BATTERSEA** LINEAR FINGER PULL CABINET KNOB  
Feature finger pull with sleek linear details. Install horizontally or vertically. Pair with our full range of Battersea products for a perfectly coordinated look.

Finishes: AB, MB, PC, SB, SN, UDB  
Base Material: Solid Brass

Dimensions  
Knob Diameter: 38mm  
Projection: 35mm  
Thickness: 9mm



Matt Black (MB)

### FINISHES:



ANTIQUÉ BRASS (AB)



MATT BLACK (MB)



POLISHED CHROME (PC)



SATIN BRASS (SB)



SATIN NICKEL (SN)



URBAN DARK BRONZE (UDB)

## Cabinet Hardware | LINEAR T-BAR CABINET KNOBS

**MHCL1675(finish) BATTERSEA** LINEAR T-BAR CABINET KNOB  
Modern T-bar style knob with precise linear details. Use with our full range of Battersea products for a complete coordinated look.

Finishes: AB, MB, PC, SB, SN, UDB  
Base Material: Solid Brass

Dimensions  
Length: 75mm  
Knob Diameter: 13mm  
Projection: 38mm



Satin Nickel (SN)

### FINISHES:



ANTIQUÉ BRASS (AB)



MATT BLACK (MB)



POLISHED CHROME (PC)



SATIN BRASS (SB)



SATIN NICKEL (SN)



URBAN DARK BRONZE (UDB)



# BATTERSEA

## Cabinet Hardware | LINEAR T-BAR CABINET PULL HANDLE

**MHCL17128(finish) BATTERSEA** LINEAR T-BAR CABINET PULL HANDLE 128MM  
Statement linear detailed pull handles in three sizes. Option to pair with selection of backplates (page 185-187).

Finishes: AB, MB, PC, SB, SN, UDB  
Base Material: Solid Brass

Dimensions  
Centre to Centre: 128mm  
Overall Length: 164mm  
Projection from Door: 38mm

Recommended Backplate: MHCBW128(finish) Wide Cabinet Handle  
Backplate 128mm



Antique Brass (AB)

### FINISHES:



ANTIQUE BRASS (AB)



MATT BLACK (MB)



POLISHED CHROME (PC)



SATIN BRASS (SB)



SATIN NICKEL (SN)



URBAN DARK BRONZE (UDB)

## Cabinet Hardware | LINEAR T-BAR CABINET PULL HANDLE

**MHCL17160(finish) BATTERSEA** LINEAR T-BAR CABINET PULL HANDLE 160MM  
Statement linear detailed pull handles in three sizes. Option to pair with selection of backplates (page 185-187).

Finishes: AB, MB, PC, SB, SN, UDB  
Base Material: Solid Brass

Dimensions  
Centre to Centre: 160mm  
Overall Length: 196mm  
Projection from Door: 38mm

Recommended Backplate: MHCBW160(finish) Wide Cabinet Handle  
Backplate 160mm



Polished Chrome (PC)

### FINISHES:



ANTIQUE BRASS (AB)



MATT BLACK (MB)



POLISHED CHROME (PC)



SATIN BRASS (SB)



SATIN NICKEL (SN)



URBAN DARK BRONZE (UDB)





# BATTERSEA

*Cabinet Hardware* | LINEAR T-BAR CABINET PULL HANDLE

**MHCL17320(finish) BATTERSEA** LINEAR T-BAR CABINET PULL HANDLE 320MM  
Statement linear detailed pull handles in three sizes. Option to pair with selection of backplates (page 185-187).

Finishes: AB, MB, PC, SB, SN, UDB  
Base Material: Solid Brass

Dimensions  
Centre to Centre: 320mm  
Overall Length: 356mm  
Projection from Door: 38mm

Recommended Backplate: MHCBW320(finish) Wide  
Cabinet Handle Backplate 320mm



Satin Brass (SB)

## FINISHES:



ANTIQUÉ BRASS (AB)



MATT BLACK (MB)



POLISHED CHROME (PC)



SATIN BRASS (SB)



SATIN NICKEL (SN)



URBAN DARK BRONZE (UDB)

# PADDINGTON

## Cabinet Hardware | SPIRAL CYLINDER CABINET KNOBS

**MHCS1420(finish) PADDINGTON** SPIRAL CYLINDER CABINET KNOB  
 Modern spiral detail with a stunning textured finish. Use with our full range of Paddington products for a complete coordinated look.

Finishes: AB, MB, PC, SB, SN, UDB  
 Base Material: Solid Brass

Dimensions  
 Knob Diameter: 20mm  
 Projection: 25mm



Satin Nickel (SN)

### FINISHES:



ANTIQUE BRASS (AB)



MATT BLACK (MB)



POLISHED CHROME (PC)



SATIN BRASS (SB)



SATIN NICKEL (SN)



URBAN DARK BRONZE (UDB)

## Cabinet Hardware | SPIRAL ROUND CABINET KNOBS

**MHCS1532(finish) PADDINGTON** SPIRAL ROUND CABINET KNOB  
 Featuring standout spiral details in a classic round knob style. Pair with our round backplate (page 188) for a statement look.

Finishes: AB, MB, PC, SB, SN, UDB  
 Base Material: Solid Brass

Dimensions  
 Knob Diameter: 32mm  
 Projection: 32mm  
 Base Diameter: 12mm

Recommended Backplate: MHCBR49(finish) Millhouse Round Backplate



Antique Brass (AB)

### FINISHES:



ANTIQUE BRASS (AB)



MATT BLACK (MB)



POLISHED CHROME (PC)



SATIN BRASS (SB)



SATIN NICKEL (SN)



URBAN DARK BRONZE (UDB)



# PADDINGTON

## Cabinet Hardware | SPIRAL T-BAR CABINET KNOBS

**MHCS1675(finish) PADDINGTON SPIRAL T-BAR CABINET KNOB**  
 Modern T-bar style knob with statement spiral texture. Use with our full range of Paddington products for a complete coordinated look.

Finishes: AB, MB, PC, SB, SN, UDB  
 Base Material: Solid Brass

Dimensions  
 Length: 75mm  
 Knob Diameter: 13mm  
 Projection: 38mm



Satin Nickel (SN)

### FINISHES:



ANTIQUE BRASS (AB)



MATT BLACK (MB)



POLISHED CHROME (PC)



SATIN BRASS (SB)



SATIN NICKEL (SN)



URBAN DARK BRONZE (UDB)

## Cabinet Hardware | SPIRAL T-BAR CABINET PULL HANDLE

**MHCS17128(finish) PADDINGTON SPIRAL T-BAR CABINET PULL HANDLE 128MM**  
 Contemporary spiral detailed pull handles in three sizes. Option to pair with selection of backplates (page 185-187).

Finishes: AB, MB, PC, SB, SN, UDB  
 Base Material: Solid Brass

Dimensions  
 Centre to Centre: 128mm  
 Overall Length: 165mm  
 Projection from Door: 38mm

Recommended Backplate: MHCBW128(finish) Wide Cabinet Handle Backplate 128mm

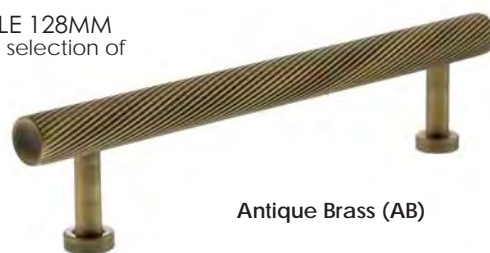

Antique Brass (AB)

### FINISHES:



ANTIQUE BRASS (AB)



MATT BLACK (MB)



POLISHED CHROME (PC)



SATIN BRASS (SB)



SATIN NICKEL (SN)



URBAN DARK BRONZE (UDB)

# PADDINGTON

## Cabinet Hardware | SPIRAL T-BAR CABINET PULL HANDLE

**MHCS17160(finish) PADDINGTON SPIRAL T-BAR CABINET PULL HANDLE 160MM**  
Contemporary spiral detailed pull handles in three sizes. Option to pair with selection of backplates (page 185-187).

Finishes: AB, MB, PC, SB, SN, UDB  
Base Material: Solid Brass

Dimensions  
Centre to Centre: 160mm  
Overall Length: 196mm  
Projection from Door: 38mm

Recommended Backplate: MHCBW160(finish) Wide Cabinet Handle Backplate 160mm



Antique Brass (AB)

### FINISHES:



ANTIQUÉ BRASS (AB)



MATT BLACK (MB)



POLISHED CHROME (PC)



SATIN BRASS (SB)



SATIN NICKEL (SN)



URBAN DARK BRONZE (UDB)

## Cabinet Hardware | SPIRAL T-BAR CABINET PULL HANDLE

**MHCS17320(finish) PADDINGTON SPIRAL T-BAR CABINET PULL HANDLE 320MM**  
Contemporary spiral detailed pull handles in three sizes. Option to pair with selection of backplates (page 185-187).

Finishes: AB, MB, PC, SB, SN, UDB  
Base Material: Solid Brass

Dimensions  
Centre to Centre: 320mm  
Overall Length: 357mm  
Projection from Door: 38mm

Recommended Backplate: MHCBW320(finish) Wide Cabinet Handle Backplate 320mm



Urban Dark Bronze (UDB)

### FINISHES:



ANTIQUÉ BRASS (AB)



MATT BLACK (MB)



POLISHED CHROME (PC)



SATIN BRASS (SB)



SATIN NICKEL (SN)



URBAN DARK BRONZE (UDB)

# CHRYSLER

## Cabinet Hardware | DIAMOND CYLINDER CABINET KNOBS

**MHCD1420(finish) CHRYSLER** DIAMOND CYLINDER CABINET KNOB  
Striking diamond textured cylinder knob. Use with our full range of Chrysler products for a complete coordinated look.

Finishes: AB, MB, PC, SB, SN, UDB  
Base Material: Solid Brass

Dimensions  
Knob Diameter: 20mm  
Projection: 25mm



Polished Chrome (PC)

### FINISHES:



ANTIQUE BRASS (AB)



MATT BLACK (MB)



POLISHED CHROME (PC)



SATIN BRASS (SB)



SATIN NICKEL (SN)



URBAN DARK BRONZE (UDB)

## Cabinet Hardware | DIAMOND ROUND CABINET KNOBS

**MHCD1530(finish) CHRYSLER** DIAMOND ROUND CABINET KNOB  
Showcasing a diamond cut texture in a timeless round knob style. Pair with our round backplate (page 188) for a statement look.

Finishes: AB, MB, PC, SB, SN, UDB  
Base Material: Solid Brass

Dimensions  
Knob Diameter: 32mm  
Projection: 30mm  
Base Diameter: 12mm



Satin Nickel (SN)

### FINISHES:



ANTIQUE BRASS (AB)



MATT BLACK (MB)



POLISHED CHROME (PC)



SATIN BRASS (SB)



SATIN NICKEL (SN)



URBAN DARK BRONZE (UDB)



# CHRYSLER

## Cabinet Hardware | DIAMOND T-BAR CABINET KNOBS

**MHCD1675(finish) CHRYSLER** DIAMOND T-BAR CABINET KNOB  
Modern T-bar style knob with luxurious diamond cut texture. Use with our full range of Chrysler products for a complete coordinated look.

Finishes: AB, MB, PC, SB, SN, UDB  
Base Material: Solid Brass

Dimensions  
Length: 75mm  
Knob Diameter: 15mm  
Projection: 40mm



Satin BRASS (SB)

### FINISHES:



ANTIQUÉ BRASS (AB)



MATT BLACK (MB)



POLISHED CHROME (PC)



SATIN BRASS (SB)



SATIN NICKEL (SN)



URBAN DARK BRONZE (UDB)

## Cabinet Hardware | DIAMOND T-BAR CABINET PULL HANDLE

**MHCD17128(finish) CHRYSLER** DIAMOND T-BAR CABINET PULL HANDLE 128MM  
Luxurious diamond cut texture pull handles in three sizes. Option to pair with selection of backplates (page 185-187).

Finishes: AB, MB, PC, SB, SN, UDB  
Base Material: Solid Brass

Dimensions  
Centre to Centre: 128mm  
Overall Length: 180mm  
Projection from Door: 39mm



Polished Chrome (PC)

### FINISHES:



ANTIQUÉ BRASS (AB)



MATT BLACK (MB)



POLISHED CHROME (PC)



SATIN BRASS (SB)



SATIN NICKEL (SN)



URBAN DARK BRONZE (UDB)



# CHRYSLER

## Cabinet Hardware | DIAMOND T-BAR CABINET PULL HANDLE

**MHCD17160(finish) CHRYSLER** DIAMOND T-BAR CABINET PULL HANDLE 160MM  
Luxurious diamond cut texture pull handles in three sizes. Option to pair with selection of backplates (page 185-187).

Finishes: AB, MB, PC, SB, SN, UDB  
Base Material: Solid Brass

Dimensions  
Centre to Centre: 160mm  
Overall Length: 210mm  
Projection from Door:  
39mm

Recommended Backplate: MHCBW160(finish) Wide Cabinet Handle  
Backplate 160mm



Satin Nickel (SN)

### FINISHES:



ANTIQUE BRASS (AB)



MATT BLACK (MB)



POLISHED CHROME (PC)



SATIN BRASS (SB)



SATIN NICKEL (SN)



URBAN DARK BRONZE (UDB)

## Cabinet Hardware | DIAMOND T-BAR CABINET PULL HANDLE

**MHCD17320(finish) CHRYSLER** DIAMOND T-BAR CABINET PULL HANDLE 320MM  
Luxurious diamond cut texture pull handles in three sizes. Option to pair with selection of backplates (page 185-187).

Finishes: AB, MB, PC, SB, SN, UDB  
Base Material: Solid Brass

Dimensions  
Centre to Centre: 320mm  
Overall Length: 372mm  
Projection from Door:  
39mm

Recommended Backplate: MHCBW320(finish) Wide Cabinet Handle  
Backplate 320mm



Matt Black (MB)

### FINISHES:



ANTIQUE BRASS (AB)



MATT BLACK (MB)



POLISHED CHROME (PC)



SATIN BRASS (SB)



SATIN NICKEL (SN)



URBAN DARK BRONZE (UDB)

# PENNINGTON

## Cabinet Hardware | HEXAGONAL CYLINDER CABINET KNOBS

**MHCH1420(finish) PENNINGTON** HEXAGONAL CYLINDER CABINET KNOB  
Sleek and architectural cylinder knob. Use with our full range of Pennington products for a complete coordinated look.

Finishes: AB, MB, PC, SB, SN, UDB  
Base Material: Solid Brass

Dimensions  
Knob Diameter: 23mm / 20mm  
Projection: 25mm



MATT BLACK (MB)

### FINISHES:



ANTIQUÉ BRASS (AB)



MATT BLACK (MB)



POLISHED CHROME (PC)



SATIN BRASS (SB)



SATIN NICKEL (SN)



URBAN DARK BRONZE (UDB)

## Cabinet Hardware | HEXAGONAL CABINET KNOBS

**MHCH1532(finish) PENNINGTON** HEXAGONAL CABINET KNOB  
Modern and sleek knob. Pair with our round backplate (page 188) for a standout look.

Finishes: AB, MB, PC, SB, SN, UDB  
Base Material: Solid Brass

Dimensions  
Knob Diameter: 37mm / 32mm  
Projection: 29mm



Satin Brass (SB)

### FINISHES:



ANTIQUÉ BRASS (AB)



MATT BLACK (MB)



POLISHED CHROME (PC)



SATIN BRASS (SB)



SATIN NICKEL (SN)



URBAN DARK BRONZE (UDB)

# PENNINGTON

## Cabinet Hardware | HEXAGONAL FINGER PULL KNOBS

**MHCH1338(finish) PENNINGTON** HEXAGONAL FINGER PULL CABINET KNOB  
 Feature finger pull in statement geometric shape. Install horizontally or vertically. Pair with our full range of Pennington products for a perfectly coordinated look.

Finishes: AB, MB, PC, SB, SN, UDB  
 Base Material: Solid Brass

Dimensions  
 Knob Diameter: 44mm  
 Projection: 38mm  
 Thickness: 9mm



Satin Brass (SB)

### FINISHES:

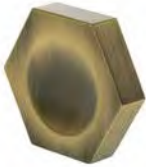

ANTIQUE BRASS (AB)



MATT BLACK (MB)



POLISHED CHROME (PC)



SATIN BRASS (SB)



SATIN NICKEL (SN)



URBAN DARK BRONZE (UDB)

## Cabinet Hardware | HEXAGONAL T-BAR CABINET KNOBS

**MHCH1675(finish) PENNINGTON** HEXAGONAL T-BAR CABINET KNOB  
 Contemporary T-bar style knob with bold hexagonal shape. Use with our full range of Pennington products for a complete coordinated look.

Finishes: AB, MB, PC, SB, SN, UDB  
 Base Material: Solid Brass

Dimensions  
 Length: 75mm  
 Knob Diameter: 16mm  
 Projection: 42mm



Polished Chrome (PC)

### FINISHES:



ANTIQUE BRASS (AB)



MATT BLACK (MB)



POLISHED CHROME (PC)



SATIN BRASS (SB)



SATIN NICKEL (SN)



URBAN DARK BRONZE (UDB)

# PENNINGTON

## Cabinet Hardware | HEXAGONAL T-BAR CABINET PULL HANDLE

**MHCH17128(finish) PENNINGTON** HEXAGONAL T-BAR CABINET PULL HANDLE 128MM  
Sleek statement pull handles in three sizes. Option to pair with selection of backplates (page 185-187).

Finishes: AB, MB, PC, SB, SN, UDB  
Base Material: Solid Brass

Dimensions  
Centre to Centre: 128mm  
Overall Length: 164mm  
Projection from Door: 42mm



Antique Brass (AB)

Recommended Backplate: MHCBW128(finish) Wide Cabinet Handle Backplate 128mm

### FINISHES:



ANTIQUÉ BRASS (AB)



MATT BLACK (MB)



POLISHED CHROME (PC)



SATIN BRASS (SB)



SATIN NICKEL (SN)



URBAN DARK BRONZE (UDB)

## Cabinet Hardware | HEXAGONAL T-BAR CABINET PULL HANDLE

**MHCH17160(finish) PENNINGTON** HEXAGONAL T-BAR CABINET PULL HANDLE 160MM  
Sleek statement pull handles in three sizes. Option to pair with selection of backplates (page 185-187).

Finishes: AB, MB, PC, SB, SN, UDB  
Base Material: Solid Brass

Dimensions  
Centre to Centre: 160mm  
Overall Length: 196mm  
Projection from Door: 42mm



Satin Nickel (SN)

Recommended Backplate: MHCBW160(finish) Wide Cabinet Handle Backplate 160mm

### FINISHES:



ANTIQUÉ BRASS (AB)



MATT BLACK (MB)



POLISHED CHROME (PC)



SATIN BRASS (SB)



SATIN NICKEL (SN)



URBAN DARK BRONZE (UDB)



# PENNINGTON

*Cabinet Hardware* | HEXAGONAL T-BAR CABINET PULL HANDLE

**MHCH17320(finish)** PENNINGTON HEXAGONAL T-BAR CABINET PULL HANDLE 320MM  
Sleek statement pull handles in three sizes. Option to pair with selection of backplates (page 185-187).

Finishes: AB, MB, PC, SB, SN, UDB  
Base Material: Solid Brass

Dimensions  
Centre to Centre: 320mm  
Overall Length: 356mm  
Projection from Door: 42mm

Recommended Backplate: MHCBW320(finish) Wide  
Cabinet Handle Backplate 320mm



Satin Brass (SB)

## FINISHES:



ANTIQUÉ BRASS (AB)



MATT BLACK (MB)



POLISHED CHROME (PC)



SATIN BRASS (SB)



SATIN NICKEL (SN)



URBAN DARK BRONZE (UDB)

# EMPIRE

## Cabinet Hardware | SLIM CABINET PULL HANDLES

**MHCN17128(finish) EMPIRE SLIM CABINET PULL HANDLE 128MM**  
Modern and sleek pull handles in three sizes. Option to pair with selection of backplates (page 185-187).

Finishes: AB, MB, PC, SB, SN, UDB  
Base Material: Solid Brass

Dimensions  
Centre to Centre: 128mm  
Overall Length: 149mm  
Projection from Door: 30mm



Matt Black (MB)

Recommended Backplate: MHCBN128(finish) Narrow Cabinet Handle Backplate 128mm

### FINISHES:



ANTIQUE BRASS (AB)



MATT BLACK (MB)



POLISHED CHROME (PC)



SATIN BRASS (SB)



SATIN NICKEL (SN)



URBAN DARK BRONZE (UDB)

## Cabinet Hardware | SLIM CABINET PULL HANDLES

**MHCN17160(finish) EMPIRE SLIM CABINET PULL HANDLE 160MM**  
Modern and sleek pull handles in three sizes. Option to pair with selection of backplates (page 185-187).

Finishes: AB, MB, PC, SB, SN, UDB  
Base Material: Solid Brass

Dimensions  
Centre to Centre: 160mm  
Overall Length: 181mm  
Projection from Door: 30mm

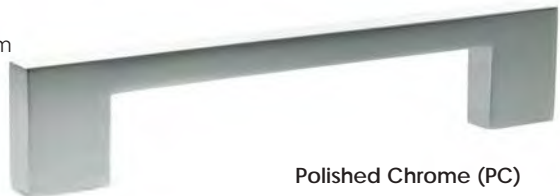

Polished Chrome (PC)

Recommended Backplate: MHCBN160(finish) Narrow Cabinet Handle Backplate 160mm

### FINISHES:



ANTIQUE BRASS (AB)



MATT BLACK (MB)



POLISHED CHROME (PC)



SATIN BRASS (SB)



SATIN NICKEL (SN)



URBAN DARK BRONZE (UDB)

# EMPIRE

## Cabinet Hardware | SLIM CABINET PULL HANDLE

### MHCN17320(finish) EMPIRE SLIM CABINET PULL HANDLE 320MM

Modern and sleek pull handles in three sizes. Option to pair with selection of backplates (page 185-187).

Finishes: AB, MB, PC, SB, SN, UDB  
Base Material: Solid Brass

Dimensions  
Centre to Centre: 320mm  
Overall Length: 341mm  
Projection from Door:  
30mm



Satin Nickel (SN)

Recommended Backplate: MHCBN320(finish) Narrow Cabinet Handle Backplate 320mm

## FINISHES:



ANTIQUE BRASS (AB)



MATT BLACK (MB)



POLISHED CHROME (PC)



SATIN BRASS (SB)



SATIN NICKEL (SN)



URBAN DARK BRONZE (UDB)

# THOMSON

## Cabinet Hardware and Accessories | PULL HANDLES

### MHPHK225UB THOMSON KNURLED CABINET T-BAR PULL HANDLE URBAN BRONZE

An elegant touch.

Finishes: UB  
Base Material: Solid Brass

Dimensions  
Centre to Centre: 225mm  
Overall Length: 273mm  
Depth of Bar: 20mm  
Projection from Door: 39mm



Urban Bronze (UB)

# NEWTON

## Cabinet Hardware and Accessories | PULL HANDLES

### MHPH725UB NEWTON T-BAR PULL HANDLE URBAN BRONZE

A statement piece.

Finishes: UB  
Base Material: Solid Brass

Dimensions  
Centre to Centre: 725mm  
Overall Length: 777mm  
Depth of Bar: 22mm  
Projection from Door: 66mm



Urban Bronze (UB)

# WATSON

## Cabinet Hardware | KNURLED CABINET KNOBS

**MHCK1820(finish) WATSON** KNURLED CYLINDER CABINET KNOB  
With detailed, precision knurling, Watson is the ultimate accessory for a modern industrial style interior.

Finishes: AB, MB, PC, SB, SN, UDB  
Base Material: Solid Brass

Dimensions  
Knob Diameter: 20mm  
Projection: 25mm



Satin Nickel (SN)

### FINISHES:



ANTIQUÉ BRASS (AB)



MATT BLACK (MB)



POLISHED CHROME (PC)



SATIN BRASS (SB)



SATIN NICKEL (SN)



URBAN DARK BRONZE (UDB)

# HARGREAVES

## Cabinet Hardware | KNURLED CABINET KNOBS

**MHCK1935(finish) HARGREAVES** KNURLED DISC CABINET KNOB  
Hargreaves offers bold, stand out design features. Creating a luxury finish to any interior.

Finishes: AB, MB, PC, SB, SN, UDB  
Base Material: Solid Brass

Dimensions  
Knob Diameter: 35mm  
Projection: 30mm  
Base Diameter: 10mm



Satin Brass (SB)

### FINISHES:



ANTIQUÉ BRASS (AB)



MATT BLACK (MB)



POLISHED CHROME (PC)



SATIN BRASS (SB)



SATIN NICKEL (SN)



URBAN DARK BRONZE (UDB)



# ACCESSORIES

## Cabinet Hardware | NARROW BACKPLATES

**MHCBN128(finish)** MILLHOUSE BRASS LONG NARROW CABINET HANDLE BACKPLATE 128MM  
Slimline backplates that coordinate with all 128mm Millhouse Brass T-bar Pull Handle styles.

Finishes: AB, MB, PC, SB, SN, UDB  
Base Material: Solid Brass

Dimensions  
Length: 204mm  
Width: 13mm  
Thickness: 5mm



Matt Black (MB)

### FINISHES:



ANTIQUE BRASS (AB)



MATT BLACK (MB)



POLISHED CHROME (PC)



SATIN BRASS (SB)



SATIN NICKEL (SN)



URBAN DARK BRONZE (UDB)

## Cabinet Hardware | NARROW BACKPLATES

**MHCBN160(finish)** MILLHOUSE BRASS LONG NARROW CABINET HANDLE BACKPLATE 160MM  
Slimline backplates that coordinate with all 160mm Millhouse Brass T-bar Pull Handle styles.

Finishes: AB, MB, PC, SB, SN, UDB  
Base Material: Solid Brass

Dimensions  
Length: 240mm  
Width: 13mm  
Thickness: 5mm

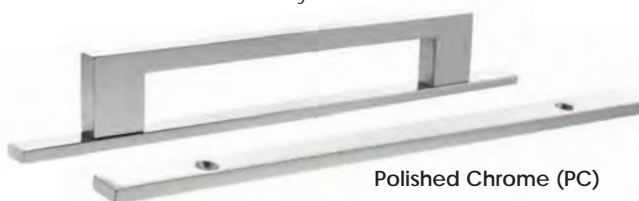

Polished Chrome (PC)

### FINISHES:



ANTIQUE BRASS (AB)



MATT BLACK (MB)



POLISHED CHROME (PC)



SATIN BRASS (SB)



SATIN NICKEL (SN)



URBAN DARK BRONZE (UDB)

# ACCESSORIES

## Cabinet Hardware | NARROW BACKPLATES

**MHCBN320(finish)** MILLHOUSE BRASS LONG NARROW CABINET HANDLE BACKPLATE 320MM  
 Slimline backplates that coordinate with all 320mm Millhouse Brass T-bar Pull Handle styles.

Finishes: AB, MB, PC, SB, SN, UDB  
 Base Material: Solid Brass

Dimensions  
 Length: 380mm  
 Width: 13mm  
 Thickness: 5mm



Antique Brass (AB)

### FINISHES:



ANTIQUÉ BRASS (AB)



MATT BLACK (MB)



POLISHED CHROME (PC)



SATIN BRASS (SB)



SATIN NICKEL (SN)



URBAN DARK BRONZE (UDB)

## Cabinet Hardware | WIDE BACKPLATES

**MHCBW128(finish)** MILLHOUSE BRASS LONG WIDE CABINET HANDLE BACKPLATE 128MM  
 Wide backplates that coordinate with all 128mm Millhouse Brass T-bar Pull Handle styles.

Finishes: AB, MB, PC, SB, SN, UDB  
 Base Material: Solid Brass

Dimensions  
 Length: 204mm  
 Width: 19mm  
 Thickness: 2mm



Satin Brass (SB)

### FINISHES:



ANTIQUÉ BRASS (AB)



MATT BLACK (MB)



POLISHED CHROME (PC)



SATIN BRASS (SB)



SATIN NICKEL (SN)



URBAN DARK BRONZE (UDB)

# ACCESSORIES

## Cabinet Hardware | WIDE BACKPLATES

**MHCBW160(finish)** MILLHOUSE BRASS LONG WIDE CABINET HANDLE BACKPLATE 160MM  
Wide backplates that coordinate with all 160mm Millhouse Brass T-bar Pull Handle styles.

Finishes: AB, MB, PC, SB, SN, UDB  
Base Material: Solid Brass

Dimensions  
Length: 236mm  
Width: 19mm  
Thickness: 2mm



Urban Dark Bronze (UDB)

### FINISHES:



ANTIQUE BRASS (AB)



MATT BLACK (MB)



POLISHED CHROME (PC)



SATIN BRASS (SB)



SATIN NICKEL (SN)



URBAN DARK BRONZE (UDB)

## Cabinet Hardware | WIDE BACKPLATES

**MHCBW320(finish)** MILLHOUSE BRASS LONG WIDE CABINET HANDLE BACKPLATE 320MM  
Wide backplates that coordinate with all 320mm Millhouse Brass T-bar Pull Handle styles.

Finishes: AB, MB, PC, SB, SN, UDB  
Base Material: Solid Brass

Dimensions  
Length: 396mm  
Width: 19mm  
Thickness: 2mm



Satin Nickel (SN)

### FINISHES:



ANTIQUE BRASS (AB)



MATT BLACK (MB)



POLISHED CHROME (PC)



SATIN BRASS (SB)



SATIN NICKEL (SN)



URBAN DARK BRONZE (UDB)

# ACCESSORIES

## Cabinet Hardware | ROUND BACKPLATES

**MHCBR49(finish)** MILLHOUSE BRASS ROUND CABINET HANDLE BACKPLATE  
Circular backplates that coordinate with all Millhouse Brass Round Knob styles.

Finishes: AB, MB, PC, SB, SN, UDB  
Base Material: Solid Brass

Dimensions  
Diameter: 49mm  
Thickness: 4mm

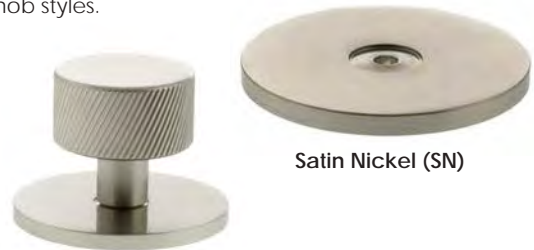

Satin Nickel (SN)

### FINISHES:



ANTIQUÉ BRASS (AB)



MATT BLACK (MB)



POLISHED CHROME (PC)



SATIN BRASS (SB)



SATIN NICKEL (SN)



URBAN DARK BRONZE (UDB)

## Cabinet Hardware | SQUARE BACKPLATES

**MHCBS50(finish)** MILLHOUSE BRASS SQUARE CABINET HANDLE BACKPLATE  
Square backplates that coordinate with all Millhouse Brass Square Knob styles.

Finishes: AB, MB, PC, SB, SN, UDB  
Base Material: Solid Brass

Dimensions  
Length: 50mm  
Width: 50mm  
Thickness: 4mm

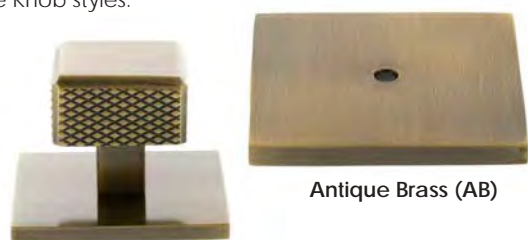

Antique Brass (AB)

### FINISHES:



ANTIQUÉ BRASS (AB)



MATT BLACK (MB)



POLISHED CHROME (PC)



SATIN BRASS (SB)



SATIN NICKEL (SN)



URBAN DARK BRONZE (UDB)

# ACCESSORIES

## Cabinet Hardware | HINGES

**MHBH50(finish)** MILLHOUSE BRASS CABINET BUTT HINGES  
50mm x 28mm x 2mm Solid Brass Cabinet Butt Hinges

Finishes:  
AB, MB, PC, SB, SN, UDB  
Base Material: Solid Brass  
Sold with matching wood screws.

Dimensions:  
Length: 50mm  
Width: 28mm  
Depth of Leaf: 2mm  
Depth of Knuckle: 6mm



Antique Brass (AB)

### FINISHES:



ANTIQUE BRASS (AB)



MATT BLACK (MB)



POLISHED CHROME (PC)



SATIN BRASS (SB)



SATIN NICKEL (SN)



URBAN DARK BRONZE (UDB)

**MHBH64(finish)** MILLHOUSE BRASS CABINET BUTT HINGES  
64mm x 35mm x 2mm Solid Brass Cabinet Butt Hinges

Finishes:  
AB, MB, PC, SB, SN, UDB  
Base Material: Solid Brass  
Sold with matching wood screws.

Dimensions:  
Length: 64mm  
Width: 35mm  
Depth of Leaf: 2mm  
Depth of Knuckle: 6mm



Antique Brass (AB)

### FINISHES:



ANTIQUE BRASS (AB)



MATT BLACK (MB)



POLISHED CHROME (PC)



SATIN BRASS (SB)

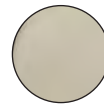

SATIN NICKEL (SN)



URBAN DARK BRONZE (UDB)

**MHBH75(finish)** MILLHOUSE BRASS CABINET BUTT HINGES  
75mm x 41mm x 2mm Solid Brass Cabinet Butt Hinges

Finishes:  
AB, MB, PC, SB, SN, UDB  
Base Material: Solid Brass  
Sold with matching wood screws.

Dimensions:  
Length: 75mm  
Width: 41mm  
Depth of Leaf: 2mm  
Depth of Knuckle: 6mm



Antique Brass (AB)

### FINISHES:



ANTIQUE BRASS (AB)



MATT BLACK (MB)



POLISHED CHROME (PC)



SATIN BRASS (SB)



SATIN NICKEL (SN)



URBAN DARK BRONZE (UDB)



# WINCHESTER

Cabinet Hardware | CABINET PULL

## OEC1176(finish) WINCHESTER CONCEALED FIX CUP PULL

This traditional styled cup pull is perfectly suited to traditional or contemporary settings. Select a finish to match your style!

Finishes: AB, AC, DS, MB, PC, SB, SN, UDB, USC  
Base Material: Solid Brass  
Concealed Fix.

Dimensions:  
Cup Pull Width: 104mm  
Height: 40mm  
Depth when fitted: 24mm  
Centre to Centre: 76mm



Antique Brass (AB)

## FINISHES:



ANTIQUE BRASS (AB)



ANTIQUE COPPER (AC)



DISTRESSED SILVER (DS)



MATT BLACK (MB)



POLISHED CHROME (PC)



SATIN BRASS (SB)



SATIN NICKEL (SN)



URBAN DARK BRONZE (UDB)



URBAN SATIN COPPER (USC)

# LINCOLN

Cabinet Hardware | CABINET KNOB

## OEC1232(finish) LINCOLN VICTORIAN CABINET KNOB 32MM

Crafted from quality, solid brass, Lincoln is a stunning classic design.

Finishes: AB, AC, DS, MB, PC, SB, SN, UDB, USC  
Base Material: Solid Brass  
Concealed Fix.

Dimensions:  
Knob Width/Diameter: 32mm  
Height: 28mm  
Width of base: 30mm  
Width of stem: 12mm



Antique Brass (AB)



Antique Brass (AB)

## OEC1238(finish) LINCOLN VICTORIAN CABINET KNOB 38MM

Crafted from quality, solid brass, Lincoln is a stunning classic design.

Finishes: AB, AC, DS, MB, PC, SB, SN, UDB, USC  
Base Material: Solid Brass  
Concealed Fix.

Dimensions:  
Knob Width/Diameter: 38mm  
Height: 33mm  
Width of base: 36mm  
Width of stem: 12mm

## FINISHES:



ANTIQUE BRASS (AB)



ANTIQUE COPPER (AC)



DISTRESSED SILVER (DS)



BLACK (MB)



POLISHED CHROME (PC)



SATIN BRASS (SB)



SATIN NICKEL (SN)



URBAN DARK BRONZE (UDB)



URBAN SATIN COPPER (USC)

Old English

CABINET HARDWARE





The image features several L-shaped metal rods of varying finishes. One prominent rod is black with a matte finish, curving from the top left towards the bottom right. Another rod is made of polished stainless steel, curving from the bottom left towards the top right. A third rod, also in stainless steel, is visible at the top right, curving from the top towards the right. The rods are set against a light, neutral background.

Whether you're outfitting a bustling office space, a dynamic retail environment, or a secure industrial facility, we have the hardware solutions you need to thrive in today's fast-paced world. Our comprehensive range of products has been meticulously crafted to meet the highest standards of quality and performance. With a focus on durability, our solutions are built to withstand the demands of various settings, providing reliable performance and long-lasting value.

# COMMERCIAL HARDWARE

# COMMERCIAL HARDWARE

## Pull Handles | BACK TO BACK FIXINGS

### APH(size)(finish) D PULL HANDLE

Bolt-Through D Pull Handle  
Base Material: Stainless Steel  
Bolt-Through fixings provided

Finishes: MB, SSS

Sizes:  
150x19mm - APH15019(MB/SSS)  
225x19mm - APH22519(MB/SSS)  
300x19mm - APH30019(MB/SSS)  
450x19mm - APH45019(MB/SSS)  
600x19mm - APH60019(MB/SSS)

Back to Back Fixings  
- APHBBF19(MB/SSS)



MB

#### FINISHES:



MATT BLACK (MB)



SATIN STAINLESS STEEL (SSS)

### APH(size)SQ(finish) MITRED PULL HANDLE

Bolt-Through Mitred Pull Handle  
Base Material: Stainless Steel  
Bolt-Through fixings provided

Finishes: MB, SSS

Sizes:  
300x19mm - APH30019SQ(MB/SSS)  
450x19mm - APH45019SQ(MB/SSS)  
600x19mm - APH60019SQ(MB/SSS)

Mitred Pull Handle Back to Back Fixings  
- APHBBF19SQ(MB/SSS)



MB

#### FINISHES:



MATT BLACK (MB)



SATIN STAINLESS STEEL (SSS)

### APH(size)TBAR(finish) T BAR PULL HANDLE

Bolt-Through T Bar Pull Handle  
Base Material: Stainless Steel

Finishes: MB, SSS

Sizes:  
450x32mm - APH45032TBAR(MB/SSS)  
600x32mm - APH60032TBAR(MB/SSS)  
1200x32mm - APH120032TBAR(MB/SSS)

T Bar Back to Back Fixings  
- APHBBF25R(MB/SSS)



MB

#### FINISHES:



MATT BLACK (MB)



SATIN STAINLESS STEEL (SSS)

### ACPC(size)(finish) D PULL HANDLE

Cabinet Pull Handle  
Base Material: Stainless Steel.  
Bolt-Through fixings provided

Finishes: MB

Sizes:  
65x10mm - ACPC6510MB  
100x10mm - ACPC10010MB  
155x10mm - ACPC15510MB



MB

#### FINISHES:



MATT BLACK (MB)

### APHBBF(size)(finish) BACK TO BACK FIXINGS

APHBBF19SQMB - Mitred Pull Handle Back to Back Fixing Kit 19mm

APHBBF19MB - Atlantic Pull Handle Back to Back Fixing Kit 19mm - Matt Black  
APHBBF19SSS - Atlantic Pull Handle Back to Back Fixing Kit 19mm - Satin Stainless Steel

APHBBF25RMB - Atlantic Pull Handle Back to Back Fixing Kit 25mm - Matt Black  
APHBBF25RSSS - Atlantic Pull Handle Back to Back Fixing Kit 25mm - Satin Stainless Steel

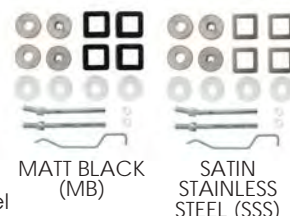

MATT BLACK (MB)

SATIN STAINLESS STEEL (SSS)

# COMMERCIAL HARDWARE

## KICK PLATES AND FINGER PLATES | DOOR STOPS

### AKP(size)(finish) KICK PLATE

Pre-drilled Kick Plates

Base Material: Stainless Steel  
Sold with matching wood screws.

Finishes: MB, SSS

Sizes:

690mm - AKP690(MB/SSS)  
720mm - AKP720(MB/SSS)  
745mm - AKP745(MB/SSS)  
760mm - AKP760(MB/SSS)  
780mm - AKP780(MB/SSS)  
800mm - AKP800(MB/SSS)  
815mm - AKP815(MB/SSS)  
855mm - AKP855(MB/SSS)  
880mm - AKP880(MB/SSS)  
905mm - AKP905(MB/SSS)  
950mm - AKP950(MB/SSS)  
960mm - AKP960(MB/SSS)  
(Bespoke sizes available upon request)



### FINISHES:



MATT BLACK (MB)



SATIN STAINLESS STEEL (SSS)

### AFP(size)(finish) FINGER PLATE

Pre-drilled Finger Plates

Base Material: Stainless Steel  
Sold with matching wood screws.

Finishes: MB, SSS

Sizes:

300x75mm - AFP30075(MB/SSS)  
350x75mm - AFP35075(MB/SSS)  
500x75mm - AFP50075(MB/SSS)  
650x75mm - AFP65075(MB/SSS)  
500x100mm - AFP500100(MB/SSS)  
700x85mm - AFP70085(MB/SSS)  
(Bespoke sizes available upon request)



### FINISHES:



MATT BLACK (MB)



SATIN STAINLESS STEEL (SSS)

### ADSCC(finish) CYLINDER DOOR STOP

Cylinder Contract Floor Mounted Door Stop

Base Material: Stainless Steel  
Sold with matching wood screws.  
Total Height: 38.5mm  
Rubber Width: 35mm  
Base Width: 32mm

Finishes: MB, SSS



### FINISHES:



MATT BLACK (MB)



SATIN STAINLESS STEEL (SSS)

### ADSHMC(finish) HALF-MOON DOOR STOP

Half-Moon Contract Floor Mounted Door Stop

Base Material: Stainless Steel  
Sold with matching wood screws.

Height from Base: 26mm  
Diameter: 40mm

Finishes: MB, SSS



### FINISHES:



MATT BLACK (MB)



SATIN STAINLESS STEEL (SSS)

# COMMERCIAL HARDWARE

## Return to Door Lever and Accessories

RETURN TO DOOR LEVER | DOOR CLOSER

### ALRTD(finish) RETURN TO DOOR LEVER

Return to Door Safety Lever 19mm on Round Rose

Base Material: Stainless Steel  
Sold with matching wood screws.  
Rose Thickness: 8mm

Finishes: MB, SSS

Dimensions:  
A: 53mm  
B: 135mm  
C: 10mm  
D: 75mm

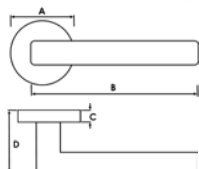

MB

FINISHES:



MATT BLACK (MB)



SATIN STAINLESS STEEL (SSS)

### AWCR(finish) WC WITH INDICATOR

WC Turn with Indicator to suit Return to Door lever

Base Material: Stainless Steel  
Sold with matching wood screws.

Finishes: MB, SSS



MB

FINISHES:



MATT BLACK (MB)



SATIN STAINLESS STEEL (SSS)

### AWCD(finish) DISABLED WC WITH INDICATOR

Disabled WC Turn with Indicator to suit Return to Door lever

Base Material: Stainless Steel  
Sold with matching wood screws.

Finishes: MB, SSS



MB

FINISHES:



MATT BLACK (MB)



SATIN STAINLESS STEEL (SSS)

### AESCK(finish) KEY ESCUTCHEON

Key Escutcheon to suit Return to Door lever

Base Material: Stainless Steel  
Sold with matching wood screws.  
Unit: Sold in Pairs

Finishes: MB, SSS



MB

FINISHES:



MATT BLACK (MB)



SATIN STAINLESS STEEL (SSS)

### AESCE(finish) EURO ESCUTCHEON

Euro Escutcheon to suit Return to Door lever

Base Material: Stainless Steel  
Sold with matching wood screws.  
Unit: Sold in Pairs

Finishes: MB, SSS



MB

FINISHES:



MATT BLACK (MB)



SATIN STAINLESS STEEL (SSS)

### ADC925(finish) DOOR CLOSER

Premium Grade Slimline Door Closer

Base Material: Stainless Steel  
Sold with matching wood screws.  
Max 110kg, DDA Compliant, Adjustable Door Closer

Finishes: AB, MB, SE, SN



MB

FINISHES:



ANTIQUÉ BRASS (AB)



MATT BLACK (MB)



SILVER (SE)



SATIN NICKEL (SN)

# COMMERCIAL HARDWARE

## Signage | DISC SIGNAGE

### ATLANTIC DISC SIGN 3M ADHESIVE 75MM

High strength and long-lasting 3M Adhesive backing.

Base Material: Stainless Steel  
Grade 201 Stainless Steel

Width: 75mm  
Depth: 3mm

Fixing: 3M Adhesive



**AS75FDKLASSS**  
Fire Door Keep Locked



**AS75PUSHSSS**  
Push



**AS75PULLASSS**  
Pull



**AS75SASSS**  
Shower



**AS75FDKCASSS**  
Fire Door Keep Clear



**AS75MASSS**  
Male



**AS75FASSS**  
Female



**AS75UASSS**  
Unisex



**AS75FDKSASSS**  
Fire Door Keep Shut



**AS75DASSS**  
Disabled



**AS75WCASSS**  
WC



**AS75BCASSS**  
Baby Change



**AS75AFDKCASSS**  
Automatic Fire Door Keep Clear

### AECP(finish) ATLANTIC EURO CYLINDER PULL

Base Material: Stainless Steel

Height: 80mm  
Width: 55mm  
Depth: 21mm

Finishes: MB, SSS



MB

#### FINISHES:



MATT BLACK (MB)



SATIN STAINLESS STEEL (SSS)

# Ermetika®

Ermetika was founded in Italy in 1987, born from the vision of the Spinazzola brothers to develop a pocket door system that maximizes living space while making a design statement. Over the years, the family business evolved from a small artisanal operation into a state-of-the-art, fully automated production line. Today, Ermetika is renowned for producing high-quality, reliable framed and frameless pocket door systems, along with flush swing aluminium door frames, all manufactured at its ISO 9001-certified facility in Barletta (BT), Italy.





When retro-fitting pocket doors into a room where the walls are already constructed and installed, there are a few aspects that must be considered before installation, to decide if a pocket door is suitable. Those aspects include wall length and thickness, load-bearing walls, wiring and much more. Pocket door installation is a straight forward process when fitting in a new build environment.

**FIND OUT  
MORE:**







# WHY CHOOSE A POCKET DOOR SYSTEM?

---

## **SPACE SAVING**

Pocket doors create more space within a room as well as making a design statement! They can also aid in creating a more accessible space. In contrast to environments with traditional hinged doors which can hinder movement, pocket doors create a larger, safer space for wheelchair users.

## **AESTHETICALLY PLEASING**

Elevating interior spaces, pocket doors are the perfect choice for creating a modern and stylish look, whether you opt for a sleek frameless pocket door system or a more traditional framed design.

# WHY CHOOSE ERMETIKA?

---

## **STRENGTH & DURABILITY**

Ermetika kits have excellent structural strength with strong metal door frames, and horizontal reinforcements. The extractable rail can be easily checked for quality sliding.

## **FLEXIBLE & EASY TO SET UP**

These kits can easily be adjusted for different wall sizes. The clear fixing points of the system and helpful floor guide allow quick and easy integration.

## **FUNCTIONALITY**

Ermetika kits are specifically engineered to provide smooth, fluid movement while ensuring silent sliding during operation.

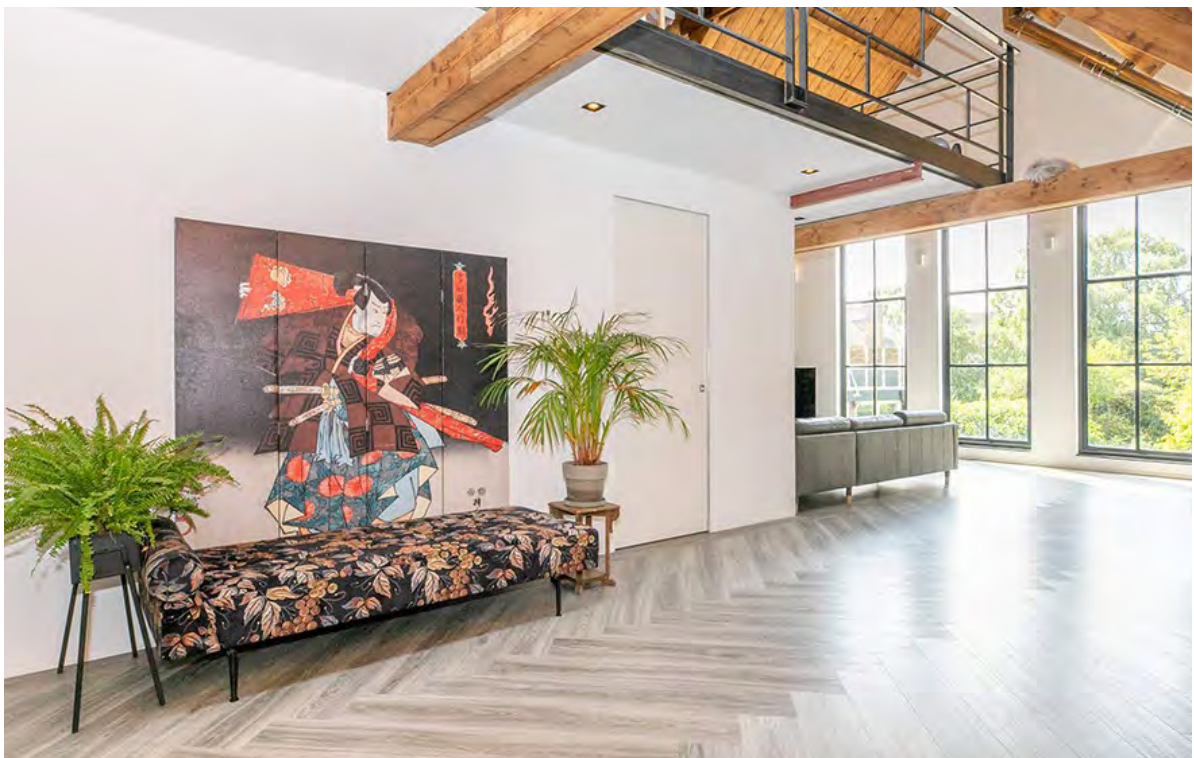

# EVOKIT

EvoKit is a **traditional framed pocket door system**, unlike other pocket door systems in the market. EvoKit is a **strong reinforced product** thanks to its galvanized steel and aluminium construction.

Since it is a Kit, transport and stocking are much easier and the installation is **fast and accurate** thanks to its **snap-fit assembly system**.

Cavity sliding door systems provide **stunning modern aesthetic** solutions and let you save precious floor space while separating it into multiple rooms.



# ABSOLUTE EVOKIT

Absolute EvoKit is a **no architrave frameless pocket door kit system**. Absolute EvoKit does **not require trims** and **creates a seamless look** with your finished wall. Ideal for those who want to create minimal design solutions with unique ease and convenience.

This kit allows for the **ultimate modern look**, with the door blending into the surrounding walls due to there being **no architraves** which facilitates a plaster reveal.



# EVOKIT FIRE

EvoKit Fire is the innovative pocket door system by Ermetika that is also **fire resistant**.

Matched with an E.I.30 door it offers the option to slow or limit the propagation of flames in the environment it is installed, raising safety and complying with fire regulations.



# JAMBS

A jamb, in architecture, is the side-post or lining of a doorway or other aperture. Jambes are fitted to cover the edges of the pocket door framework and the opening into the pocket. The size of the jamb you require is dictated by the **thickness of your door** and the **thickness of your wall**.

Ermetika kits can be fitted with **white jambs** (including white brushes & seals) or **wood jambs**. Wood jambs are ready to be lacquered or varnished as suited and include black brushes and brown seals. More details are beside each kit on the following pages.

## EXTRA FEATURES

The Ermetika **soft close system** can be added to any pocket door kit to give additional functionality and a **smooth gliding closing motion**. This system fits into the existing track.

Any Ermetika single pocket door system can easily be transformed into a **double door kit** with the Ermetika **Junction Kit**.



Ermetika®

## BUYING GUIDE:

### 1. Find out the **SIZE OF YOUR DOOR**

### 2. Select which **POCKET DOOR KIT** you would like: - **EVOKIT** - **ABSOLUTE EVOKIT** - **EVOKIT FIRE**

**3.** If you have chosen **EVOKIT** in **STEP 2**, select which **COLOUR JAMBS** you require to match your door and then find the row in the relevant jambs table which has your **DOOR SIZE** mentioned. Then work out what width **JAMBS** you will require depends on your wall thickness (info above to help). The last **TWO COLUMNS** of the table show you the final code you will need to use to purchase the item determined by the **JAMB SIZE** you have chosen.

**4.** If you have chosen **ABSOLUTE EVOKIT** in **STEP 2**, then you do not need to choose jambs as these come pre-selected with the kit. Simply find the **ROW** in the table which has your **DOOR SIZE** mentioned. The last **COLUMN** of the table shows you the final code you will need to use to purchase the item.

**5.** If you have chosen **EVOKIT FIRE** in **STEP 2**, then you do not need to choose jambs as these come pre-selected with the kit. Simply find the **ROW** in the table which has your **DOOR SIZE** mentioned. The last **COLUMN** of the table shows you the final code you will need to use to purchase the item.

**6.** If you require **DOUBLE DOORS**, then please add the EACC313 to your list of items to purchase. Only available with EvoKit.

**7.** If you require **SOFT CLOSE**, then please add the items from Page 209 to your list of items to purchase.

**8.** Choose your **POCKET DOOR HARDWARE** (Page 210), and order that also! If your Pocket Door System is for a bathroom you will require a bathroom lock set.



## EVOKIT POCKET DOOR SYSTEM

EvoKit is a **classic framed sliding pocket door system**, which comes in a **kit format**. Providing up to 10% more space in a room, Pocket Door Systems are not only a way to make an **modern design statement**, but also a practical way to **save space**.

Installation is fast, easy and precise thanks to the Ermetika **snap-fit** assembly system, reducing installation times and therefore labour costs. The system is also **very adaptable**.

As the EvoKit is a framed pocket door system, Jambes are required with this kit.



EvoKit Frame



Wood Jambes

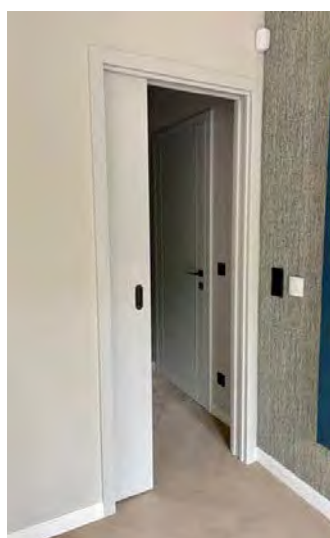
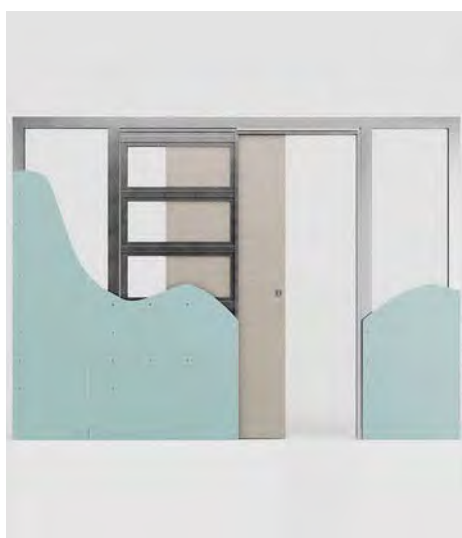

Thanks to its **efficient snap-together system**, EvoKit is quick and easy to assemble and is a practical and stylish way to save space.

Choose which **COLOUR (WOOD OR WHITE)** jambs you would like with your EvoKit system to match your door. Ermetika kits can be fitted with **WHITE JAMBS** (including white brushes & seals) or **WOOD JAMBS**. Wood jambs are ready to be lacquered or varnished as suited and include black brushes and brown seals. Jambs need to be selected to suit the **THICKNESS OF YOUR WALL**. We offer two options for 100mm wall thickness, or 125mm wall thickness.

Select the table below which shows the **COLOUR JAMBS** you require and then find the row which has your **DOOR SIZE** mentioned. The last **TWO COLUMNS** of the table show you the final code you will need to use to purchase the item determined by the **JAMB SIZE** you have chosen.

<b>WOOD JAMBS</b>								
THE CODES IN THE GREY COLOUR BOXES ARE WHAT YOU SHOULD USE TO ORDER								
ALL DIMENSIONS ARE IN MM.								
KIT SIZES	POCKET DOOR KIT FRAME SIZE						JAMB SIZE	
	PASSAGE OPENING WIDTH	PASSAGE OPENING HEIGHT	DOOR WIDTH	DOOR HEIGHT	OVERALL KIT WIDTH	OVERALL KIT HEIGHT	100MM WALL THICKNESS	125MM WALL THICKNESS
	580	1970	610	1981	1290	2060	EEK1DRW	EEK2DRW
	660	1970	686	1981	1470	2060	EEK1FRW	EEK2FRW
	740	1970	762	1981	1650	2060	EEK1GRW	EEK2GRW
	810	1970	838	1981	1720	2060	EEK1HRW	EEK2HRW
	890	1970	914	1981	1900	2060	EEK1ERW	EEK2ERW
	600	2030	626	2040	1320	2110	EEK1JRW	EEK1JWH
	700	2030	726	2040	1510	2120	EEK1ARW	EEK2ARW
	800	2030	826	2040	1710	2120	EEK1BRW	EEK2BRW
	900	2030	926	2040	1910	2120	EEK1CRW	EEK2CRW
	1000	2030	1026	2040	2120	2110	EEK1KRW	EEK2KRW

<b>WHITE JAMBS</b>								
THE CODES IN THE GREY COLOUR BOXES ARE WHAT YOU SHOULD USE TO ORDER								
ALL DIMENSIONS ARE IN MM.								
KIT SIZES	POCKET DOOR KIT FRAME SIZE						JAMB SIZE	
	PASSAGE OPENING WIDTH	PASSAGE OPENING HEIGHT	DOOR WIDTH	DOOR HEIGHT	OVERALL KIT WIDTH	OVERALL KIT HEIGHT	100MM WALL THICKNESS	125MM WALL THICKNESS
	580	1970	610	1981	1290	2060	EEK1DWH	EEK2DWH
	660	1970	686	1981	1470	2060	EEK1FWH	EEK2FWH
	740	1970	762	1981	1650	2060	EEK1GWH	EEK2GWH
	810	1970	838	1981	1720	2060	EEK1HWH	EEK2HWH
	890	1970	914	1981	1900	2060	EEK1EWH	EEK2EWH
	600	2030	626	2040	1320	2110	EEK2JRW	EEK2JWH
	700	2030	726	2040	1510	2120	EEK1AWH	EEK2AWH
	800	2030	826	2040	1710	2120	EEK1BWH	EEK2BWH
	900	2030	926	2040	1910	2120	EEK1CWH	EEK2CWH
	1000	2030	1026	2040	2120	2110	EEK1KWH	EEK2KWH

More sizes are available on special order, with a 5-6 weeks lead time.





## ABSOLUTE EVOKIT

Absolute EvoKit is a **frameless pocket door kit system**. With an easy to remove track for any future maintenance, Absolute EvoKit does **not require trims or architraves**, creating a **seamless look** with your finished wall.

This kit allows for the **ultimate modern look**, with the door blending into the surrounding walls due to there being **no architraves** which facilitates a plaster reveal. Absolute EvoKit has no jambs but aluminium edges instead, which create a clean and sleek finish.

Creating **more space** within a room, the kit runs smoothly along the tracks offering an **elegant gliding motion**. Quick and easy to assemble, Ermetika kits are fully tested for **100,000** opening and closing cycles.



**Ideal for those who want to create minimalistic design statement with unique ease and convenience.**

### POCKET DOOR KIT FRAME SIZE

THE CODES IN THE GREY COLOUR BOXES ARE WHAT YOU SHOULD USE TO ORDER  
ALL DIMENSIONS ARE IN MM.

KIT SIZES	PASSAGE OPENING WIDTH	PASSAGE OPENING HEIGHT	DOOR WIDTH	DOOR HEIGHT	OVERALL KIT WIDTH	OVERALL KIT HEIGHT	KIT CODES
	660	1990	686	1981	1480	2050	EAESCUK5
	740	1990	762	1981	1660	2050	EAESCUK9

Find the **ROW** in the table which has your **DOOR SIZE** mentioned. The last **COLUMN** of the table shows you the final code you will need to use to purchase the item. These two kits are for 100mm wall thickness. More sizes are available on special order, with a 5-6 weeks lead time.



# EVOKIT FIRE

EvoKit Fire is the innovative pocket door system by Ermetika that is also **fire resistant**.

Matched with an E.I.30 door it offers the option to slow or limit the propagation of flame in the environment it is installed, raising safety and complying with fire regulations.

This kit includes:

- Hardwood door jambs 100mm finished wall thickness
- Self-centering floor guide with anti-warp profile
- Self-closing mechanism
- Intumescent strips

(Fire Door Not Included)

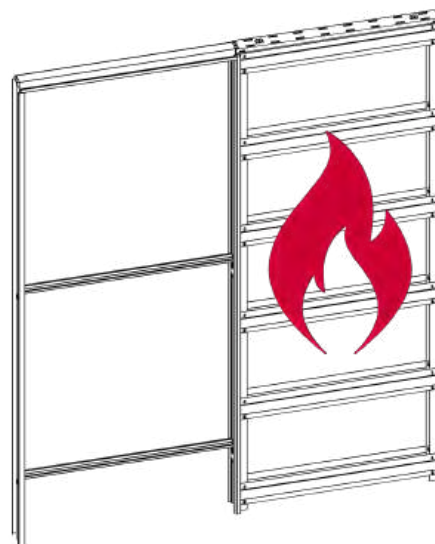

BSEN 1634-1:2009



FD 30

Fully tested and approved to BS EN 1634-1:2009 by Exova Warrington fire & UNI EN 13501-2:2016.

## POCKET DOOR KIT FRAME SIZE

THE CODES IN THE GREY COLOUR BOXES ARE WHAT YOU SHOULD USE TO ORDER  
ALL DIMENSIONS ARE IN MM.

	PASSAGE OPENING WIDTH	PASSAGE OPENING HEIGHT	DOOR WIDTH	DOOR HEIGHT	OVERALL KIT WIDTH	OVERALL KIT HEIGHT	KIT CODES
KIT SIZES	635	1960	686	1981	1470	2062	EEFSCUK3
	655	1960	711	1981	1490	2062	EEFSCUK4
	715	1960	762	1981	1650	2062	EEFSCUK5

Find the **ROW** in the table which has your **DOOR SIZE** mentioned. The last **COLUMN** of the table shows you the final code you will need to use to purchase the item. More sizes are available on special order, with a 5-6 weeks lead time.

# ACCESSORIES SPARE PARTS

---

## TROLLEY COMPLETE SET STANDARD

The complete trolley set.

CAPACITY 100KG: **ERIC901**

CAPACITY 120KG: **ERIC902**



## ERIC903 DOOR STOPPER FOR EVOKIT/ABSOLUTE EVOKIT BLACK

Black door stopper.



## ERIC904 PLUG HANG TROLLEY

Plug hang trolley.



## ERIC928 FLOOR GUIDE SET

Floor guide set.



## ERIC905 SCREW/BOLT KIT FOR TRACK KIT

Screw and bolt kit for track kit.



## ERIC907 REAR BUMPER FOR SLIDING DOOR

Rear bumper for sliding doors.



## EACC406 COMPENSATOR RING FOR HANDLES

Compensator Ring.



## EC02400009 ADAPTOR FOR SIMULTANEOUS OPENING KIT

Ermetika Grey Adaptor for Simultaneous opening kit

---





## EXTRA FEATURES

The Ermetika **soft close system** can be added to any pocket door kit to give additional functionality and a **smooth gliding closing motion**. This system fits into the existing track. Ermetika EvoKit single pocket door systems can easily be transformed into a **double door kit** with the Ermetika **Junction Kit**.

### SOFT CLOSE FOR POCKET DOOR KIT

This is an extra track/system that is added into the existing frame to create the soft close feature.



**EACC305** Ermetika EvoKit Easy-Stop Soft Closing Kit for EvoKit 40kg

**EACC333** Ermetika EvoKit Easy-Stop Soft Closing Kit for Absolute EvoKit 50kg

### EACC313 JUNCTION KIT FOR DOUBLE POCKET DOOR - EVOKIT ONLY

Extra track/system which is added into the frame to create the door into a double pocket door.

Works with EvoKit only.



### EACC309 EVOKIT SIMULTANEOUS OPENING KIT

For Double Doors

Ermetika's Simultaneous Opening Kit allows the simultaneous opening of the two doors by opening just one door. The tension mechanism creates a fluid movement of all the doors.



# POCKET DOOR HARDWARE

Accessories | SLIDING DOOR FLUSH PULL

## AGB SLIDING DOOR FLUSH PULL ROUND

Round Flush Pull to suit Ermetika Pocket Doors

Base Material: Steel

Dimensions:  
 Inside of Pull: 45.5mm  
 Diameter of rear of pull: 48mm  
 Overall Pull diameter: 60mm  
 Depth of Finger Pull: 24mm  
 Inside of Finger Pull: 19mm  
 Overall diameter of Finger Pull: 25mm

Finishes:  
 MB: B019201093  
 PB: B019201003  
 SC: B019201032



PB

## AGB SLIDING DOOR FLUSH PULL SQUARE

Square Flush Pull to suit Ermetika Pocket Doors

Base Material: Steel

Dimensions:  
 Inside of Pull: 45.5mm  
 Diameter of rear of pull: 48 mm  
 Depth of Finger Pull: 24mm  
 Inside of Finger Pull: 19mm  
 Overall diameter of Finger Pull: 25mm

Finishes:  
 MB: B019301093  
 PB: B019301003  
 SC: B019301032



MB

## AGB SLIDING DOOR BATHROOM LOCK SET WITH FLUSH PULL ROUND

Round Flush Pull to suit Ermetika Pocket Doors

Base Material: Steel

Dimensions:  
 Backset: 50mm  
 Faceplate height: 160mm  
 Case height: 106mm  
 Spindle: 8mm  
 Inside of Pull: 45.5mm  
 Diameter of rear of pull: 48mm  
 Overall Pull diameter: 60mm

Finishes:  
 MB: B046815093  
 PB: B046815003  
 SC: B046815034



SC

## AGB SLIDING DOOR BATHROOM LOCK SET WITH FLUSH PULL SQUARE

Square Flush Pull to suit Ermetika Pocket Doors

Base Material: Steel

Dimensions:  
 Backset: 50mm  
 Faceplate height: 160mm  
 Case height: 106mm  
 Spindle: 8mm  
 Inside of Pull: 45.5mm  
 Diameter of rear of pull: 48 mm

Finishes:  
 MB: B046515093  
 PB: B046515003  
 SC: B046515034



MB

Ermetika®

Ermetika®







# ATLANTIC ACCESSORIES

Along with every stunning lever, should be a complete suite of complementary ironmongery. Whether it's matching hinges, a designer door stop or simply a latch and lock faceplate.

Here at Atlantic UK, we truly believe the finish matters! For us, the finishing touch to an interior is a full kit of door hardware, that's why we offer complete coordinated set of ironmongery for a stylish, seamless look.

# HINGES

## Accessories | 3" HINGES

### A2HB32525(finish) ATLANTIC 3" HINGES

3" X 2.5" X 2.5mm Ball Bearing Hinges  
 Base Material: Steel  
 Sold with matching wood screws.  
 Sold in pairs

Dimensions:  
 Length: 75mm  
 Full Width: 63mm  
 Depth of Leaf: 2.5mm  
 Depth of Knuckle: 10mm

Finishes: AB, BN, BP, DS, MAB, MB, MBN, PC, SC, SN

### A2HB32525(finish)(3) ATLANTIC 3" HINGES PACKS OF 3:

Finishes: AB(3), BN(3), DS(3), MAB(3), MB(3), MBN(3), PB(3), PC(3), SC(3), SN(3)  
 \*Further finishes may be available in packs of 3 - enquire to find out more.



#### Finishes:

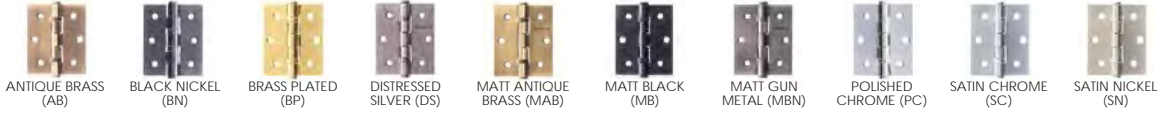

### AH322(finish) ATLANTIC 3" HINGES

3" X 2" X 2mm Ball Bearing Hinges  
 Base Material: Iron  
 Sold with matching wood screws.  
 Sold in pairs

Dimensions:  
 Length: 76mm  
 Width: 49mm  
 Depth of Leaf: 2mm  
 Depth of Knuckle: 11mm

Finishes: EB, MB, PC, SC

### AH322(finish)(3) ATLANTIC 3" HINGES PACKS OF 3:

Finishes: MB(3)

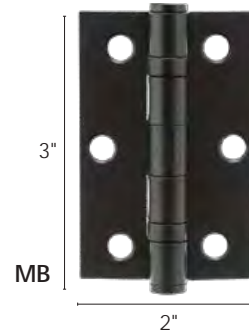

#### Finishes:

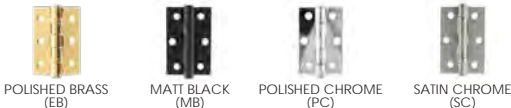

### A2H322(finish) ATLANTIC GRADE 7 FIRE RATED CE UKCA BALL BEARING 3" HINGES

3" X 2" X 2mm Ball Bearing Hinges  
 Grade 7 Fire Rated FD30/60 Fire Door Hinge  
 \*TO BE COMPLIANT MUST BE USED WITH INTUMESCENTS - PAGE 247  
 Base Material: Stainless Steel  
 Sold with matching wood screws.  
 Sold in pairs

Dimensions:  
 Height: 76mm  
 Width (open hinge): 51 mm  
 Depth of Leaf: 2 mm  
 Depth of Knuckle: 11 mm  
 Knuckle height: 84mm

Finishes:  
 AB, AC, BN, DS, MAB, MB, MBN, PB, PC, PN, PSS, SB, SN, SSS, UB, UDB, USC

### A2H322(FINISH)(3) ATLANTIC GRADE 7 CE FIRE RATED BALL BEARING 3" HINGES PACKS OF 3:

AB(3), BN(3), MB(3), PC(3), PSS(3), SC(3), SSS(3)

Intumescent Pad FD30 - AHPFR32FD30  
 Intumescent Pad FD60 - AHPFR32FD60



#### Finishes:



# HINGES

## Accessories | 4" HINGES

### AH1433(finish) ATLANTIC GRADE 13 FIRE RATED CE UKCA BALL BEARING 4" HINGES

4" X 3" X 3mm Ball Bearing Hinges  
 Grade 13 Fire Rated FD30/60 Fire Door Hinge  
 \*TO BE COMPLIANT MUST BE USED WITH INTUMESCENTS - PAGE 247  
 Base Material: Stainless Steel  
 Sold with matching wood screws.  
 Sold in pairs

Dimensions:  
 Length: 102mm  
 Width: 76mm  
 Depth of Leaf: 3mm  
 Depth of Knuckle: 14mm

Finishes:  
 AB, AC, BN, DS, EB, MAB, MB, MBN,  
 PSS, SB, SSS, UB, UDB, USC

**AH1433(finish)(3) ATLANTIC UKCA 4" HINGES**  
**PACKS OF 3:**  
 AB(3), BN(3), EB(3), MB(3), MBN(3),  
 PSS(3), SSS(3), UB(3)

**RADIUS CORNER:**  
 AHR1433(finish)  
 BN, MB, PSS, PSS(3), SSS, SSS(3), UB

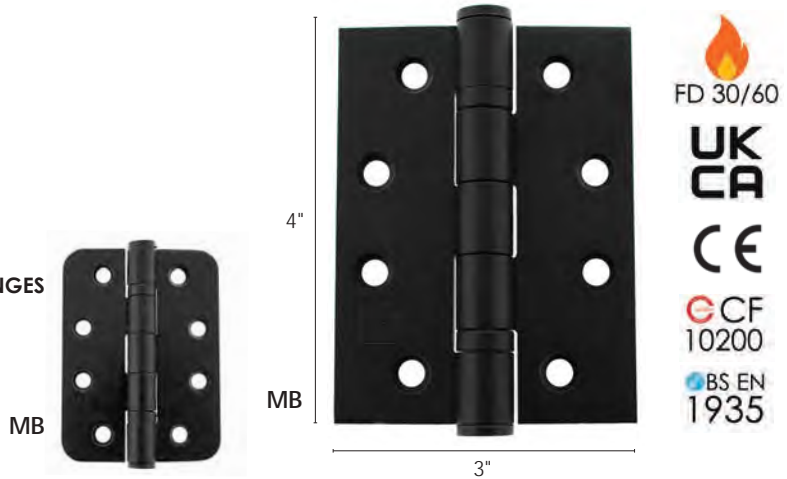

#### Finishes:



### AHG111433(finish) ATLANTIC GRADE 11 FIRE RATED CE UKCA BALL BEARING 4" HINGES

4" X 3" X 3mm Ball Bearing Hinges  
 Grade 11 Fire Rated FD30/60 Fire Door Hinge  
 \*TO BE COMPLIANT MUST BE USED WITH INTUMESCENTS - PAGE 247  
 Base Material: Mild Steel  
 Sold with matching wood screws.  
 Sold in pairs

Dimensions:  
 Length: 102mm  
 Width: 76mm  
 Depth of Leaf: 3mm

Finishes:  
 AB, BN, MB, PC, SC, SN, SSS, UB



#### Finishes:



# HINGES

## Accessories | SLIM KNUCKLE HINGES

### AH42525(finish) ATLANTIC SLIM KNUCKLE BALL BEARING 4" HINGES

4" X 2.5" X 2.5mm Ball Bearing Hinges  
 Base Material: Mild Steel  
 Sold with matching wood screws.  
 Sold in pairs

Dimensions:  
 Height: 101.5mm  
 Width (open hinge): 63mm  
 Depth of Leaf: 2.5mm  
 Depth of Knuckle: 10mm  
 Knuckle height: 105mm

Finishes:  
 MAB, MB, PB, PSS, SSS

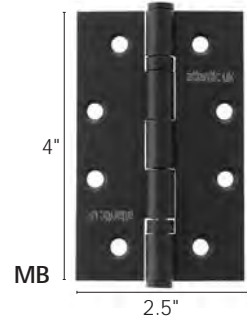

Finishes:



## Accessories | PARLIAMENT HINGES

### APH424(finish) ATLANTIC 4" PARLIAMENT HINGES

4" X 2" X 4mm Solid Brass Parliament Hinges  
 Base Material: Solid Brass  
 Sold with matching wood screws.  
 Sold in pairs

Dimensions: Length: 102mm Width: 102mm  
 Depth of Leaf: 4mm  
 Depth of Knuckle: 11mm

Finishes:  
 AB, AC, BN, DS, MAB, MB, MBN, PB, PC, PN, SB, SC, SN, UB, UDB, USC

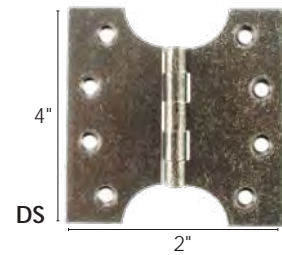

Finishes:



## Accessories | WASHERED HINGES

### AWH3222(finish) ATLANTIC 3" WASHERED HINGES

3" X 2" X 2.2mm Solid Brass Washered Hinges  
 Base Material: Solid Brass  
 Sold with matching wood screws.  
 Sold in pairs

Dimensions: Length: 76mm Width: 50mm  
 Depth of Leaf: 2.2mm  
 Depth of Knuckle: 8mm

Finishes:  
 AB, AC, BN, DS, MAB, MB, MBN, PB, PC, PN, SB, SC, SN, UB, UDB, USC

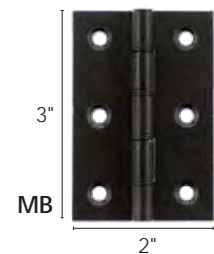

Finishes:



### CABINET HARDWARE HINGES

Available in 3 sizes. See page 189 for more information.



# AGB HINGES



## Accessories | CONCEALED HINGES

### KEY FEATURES OF THE AGB CONCEALED HINGES:

- Ideal even for **aluminium** frames, thanks to the 4mm thickness of the hinge fastening
- **Completely invisible** thanks to slim dimensions - **ideal for minimalist interiors**
- Easy installation: sash & frame parts can be **installed separately** during production and joined on-site
- Suit **wooden or aluminium** doors
- When fitted, it allows the door to open **180 degrees**
- Suitable for flush doors with rebate or without rebate
- Suitable for fire & smoke resistant doors for up to **30 minutes**

### ADJUSTMENTS



- 1**  
Pressure Adjustments
- 2**  
Vertical Adjustments
- 3**  
Horizontal Adjustments

### AGBH32(finish) AGB ECLIPSE FIRE RATED ADJUSTABLE CONCEALED HINGE

Fire Resistant- Concealed Hinge for flush doors.

Base Material: Zamak  
Suitable for wood & aluminium doors.  
Adjustable.  
Sold in singles.  
Screws not supplied.

Dimensions:  
Height: 115mm  
Max Extension: 14mm  
Capacity:  
40kg - 2 hinges  
60kg - 3 hinges

Finishes:  
MAB, MB, PB, PN, SC, SN, WH

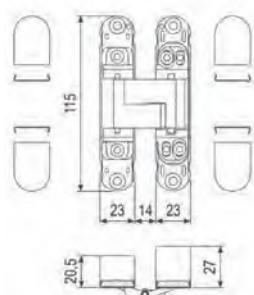

#### Finishes:



### AGBH32SHD(finish) AGB ECLIPSE 3.2 HEAVY DUTY SELF-CLOSE CONCEALED HINGE FOR 60KG DOOR

Heavy Duty Concealed Hinge for 60kg doors.

Base Material: Zamak /Steel  
Suitable for wood & aluminium doors.  
Adjustable.  
Sold in singles.  
Screws not supplied.

Dimensions:  
Height: 115mm  
Max Extension: 14mm  
Capacity: 60kg

Finishes:  
MAB, MB, PB, PN, SC, SN, WH

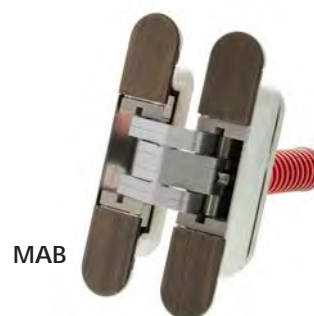

#### Finishes:



### AGBE32CHJA AGB CONCEALED HINGE JIG

This jig is suitable for the AGB Eclipse 3.2 range, including the 3.2 HD Concealed Hinge and 3.2 HD SELF-CLOSE Concealed Hinge, providing that the correct depth is drilled/routed out for.

Comes with the jig and 2 inserts. Atlantic UK recommend that this is only used on new doors and doors frames. Suitable for doors that are 35mm and upward, and with frame rebates that are no more than 12mm deep.



# MORTICE LATCHES

## Accessories | TUBULAR MORTICE LATCHES

### AL25(finish) 2.5" TUBULAR LATCH

2.5" Quality Bolt Through Tubular Latch

Base Material: Pressed Steel  
Sold with matching wood screws.

Dimensions:  
Total Length: 63mm  
Backset: 45mm  
Faceplate Size (Removable): 58mm x 27mm  
Dust Box: Yes

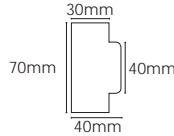

MBN

Finishes:

AB, AC, BN, DS, MAB, MB, MBN, PB, PC, PN, RB, SB, SC, SN, UB, UDB, USC

Finishes:



### AL3(finish) 3" TUBULAR LATCH

3" Heavy Duty Double Sprung Bolt Through Tubular Latch

Base Material: Pressed Steel  
Sold with matching wood screws.

Dimensions:  
Total Length: 80mm  
Backset: 60mm  
Faceplate (Removable): 58mm x 27mm  
Dust Box: Yes

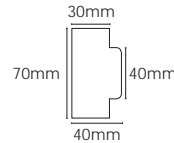

MAB

Finishes:

AB, AC, BN, DS, MAB, MB, MBN, BP, PC, PN, RB, SB, SC, SN, UB, UDB, USC

Finishes:



### AL4(finish) 4" TUBULAR LATCH

4" Heavy Duty Double Sprung Bolt Through Tubular Latch

Base Material: Pressed Steel  
Sold with matching wood screws.

Dimensions:  
Total Length: 100mm  
Backset: 75mm  
Faceplate Size (Removable): 58mm x 27mm  
Dust Box: Yes

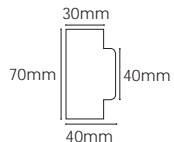

SC

Finishes:

AB, AC, BN, DS, MAB, MB, MBN, BP, PC, PN, RB, SB, SC, SN, UB, UDB, USC

Finishes:



# MORTICE LATCHES

Accessories | TUBULAR MORTICE LATCHES - CE CERTIFIRE

## ALCE25(finish) 2.5" UKCA CE CERTIFIRE ATLANTIC TUBULAR LATCH

2.5" CE Certifire Bolt Through Tubular Latch  
\*TO BE COMPLIANT MUST BE USED WITH INTUMESCENTS - PAGE 247-248

Base Material: Mild Steel, Zinc Bolt  
Sold with matching wood screws.  
Dimensions:  
Total Length: 65mm  
Backset: 45mm  
Faceplate Size: 58mm x 27mm  
Dust Box: Yes

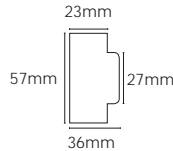

PC



Finishes:  
AB, AC, BN, DS, MAB, MB, MBN, PB,  
PC, PN, SB, SC, SN, UB, UDB, USC

### Finishes:



## ALRCE25(finish) 2.5" UKCA CE CERTIFIRE ATLANTIC RADIUS TUBULAR LATCH

2.5" CE Certifire Bolt Through Radius Corner Tubular Latch

All Finishes mentioned above available as radius corner version.



## ALCE3(finish) 3" UKCA CE CERTIFIRE ATLANTIC TUBULAR LATCH

3" CE Certifire Bolt Through Tubular Latch  
\*TO BE COMPLIANT MUST BE USED WITH INTUMESCENTS - PAGE 247-248

Base Material: Mild Steel, Zinc Bolt  
Sold with matching wood screws.  
Dimensions:  
Total Length: 78mm  
Backset: 57mm  
Faceplate Size: 58mm x 27mm  
Dust Box: Yes

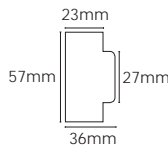

SN



Finishes:  
AB, AC, BN, DS, MAB, MB, MBN, PB,  
PC, PN, SB, SC, SN, UB, UDB, USC

### Finishes:



## ALRCE3(finish) 3" UKCA CE CERTIFIRE ATLANTIC RADIUS TUBULAR LATCH

3" CE Certifire Bolt Through Radius Corner Tubular Latch

All finishes mentioned above available as radius corner version.

## ALSO AVAILABLE - AL6(finish) 6" TUBULAR LATCH

6" Heavy Duty Double Sprung Bolt Through Tubular Latch

Dimensions:  
Total Length: 150mm  
Backset: 125mm  
Faceplate Size: 58mm x 27mm  
Dust Box: Yes



Available in all finishes.

# DEADBOLTS

## Accessories | TUBULAR MORTICE DEADBOLTS

### ADB25(finish) 2.5" TUBULAR DEADBOLT

2.5" Quality Non-Bolt Through Tubular Deadbolt

Base Material: Zinc  
 Sold with matching wood screws.  
 Dimensions:  
 Total Length: 63mm  
 Backset: 45mm  
 Faceplate Size (Removable): 58mm x 27mm  
 Keep & Dust Box: Yes  
 Operated by 5mm Spindle



PN

Finishes:  
 AB, AC, BN, DS, MAB, MB, MBN, PB, PC, PN, RB, SB, SC, SN, UB, UDB, USC

#### Finishes:



### ADB3(finish) 3" TUBULAR DEADBOLT

3" Non-Bolt Through Tubular Deadbolt

Base Material: Zinc  
 Sold with matching wood screws.  
 Dimensions:  
 Total Length: 80mm  
 Backset: 60mm  
 Faceplate Size(Removable): 58mm x 27mm  
 Keep & Dust Box: Yes  
 Operated by 5mm Spindle



PB

Finishes:  
 AB, AC, BN, DS, AB, MB, MBN, PB, PC, PN, RB, SB, SC, SN, UB, UDB, USC

#### Finishes:



### ADB4(finish) 4" TUBULAR DEADBOLT

4" Non-Bolt Through Tubular Deadbolt

Base Material: Zinc  
 Sold with matching wood screws.  
 Dimensions:  
 Total Length: 100mm  
 Backset: 75mm  
 Faceplate Size (Removable): 58mm x 27mm  
 Keep & Dust Box: Yes  
 Operated by 5mm Spindle



SC

Finishes Available:  
 AB, AC, BN, DS, MAB, MB, MBN, PB, PC, PN, RB, SB, SC, SN, UB, UDB, USC

#### Finishes:



# DEADBOLTS

Accessories | TUBULAR MORTICE DEADBOLTS - CE CERTIFIRE

## ADBCE25(finish) 2.5" UKCA CE CERTIFIRE ATLANTIC TUBULAR DEADBOLT

2.5" CE Certifire Bolt Through Tubular Deadbolt  
\*TO BE COMPLIANT MUST BE USED WITH INTUMESCENTS - PAGE 247-248

Base Material: Zinc. Bolt = Brass  
Sold with matching wood screws.  
Dimensions:  
Total Length: 65mm  
Backset: 45mm  
Faceplate Size: 58 x 27mm  
Dust Box: Yes

Finishes:  
AB, AC, BN, DS, MAB, MB, MBN, PB, PC,  
PN, SB, SC, SN, UB, UDB, USC



BN



### Finishes:



## ADBRCE25(finish) 2.5" UKCA CE CERTIFIRE ATLANTIC RADIUS TUBULAR DEADBOLT

2.5" CE Certifire Bolt Through Radius Corner Tubular Deadbolt

All Finishes mentioned above available as radius corner version.



## ADBCE3(finish) 3" UKCA CE CERTIFIRE ATLANTIC TUBULAR DEADBOLT

3" Bolt Through Tubular Deadbolt  
\*TO BE COMPLIANT MUST BE USED WITH INTUMESCENTS - PAGE 247-248

Base Material: Zinc. Bolt = Brass  
Sold with matching wood screws.  
Dimensions:  
Total Length: 78mm  
Backset: 57mm  
Faceplate Size: 58 x 27mm  
Dust Box: Yes

Finishes:  
AB, AC, BN, DS, MAB, MB, MBN, PB, PC,  
PN, SB, SC, SN, UB, UDB, USC



MB



### Finishes:



## ADBRCE3(finish) 3" UKCA CE CERTIFIRE ATLANTIC RADIUS TUBULAR DEADBOLT

3" CE Certifire Bolt Through Radius Corner Tubular Deadbolt

All Finishes mentioned above available as radius corner version.



# SMART LATCHES & DEADBOLTS

## Accessories | SMART TUBULAR LATCH

### ASL3(finish) 3" SMART TUBULAR LATCH

3" Smart Bolt Through Tubular Latch

Base Material: Zinc  
Sold with matching wood screws.

Dimensions:  
Case Size: 77x20mm  
Backset: 57mm  
Keep: Yes  
Faceplate: 25mm

Finishes:  
MB, PC, SC



MB

#### Finishes:



MATT BLACK  
(MB)



POLISHED CHROME  
(PC)



SATIN CHROME  
(SC)

## Accessories | SMART TUBULAR DEADBOLT

### ASDB3(finish) 3" SMART TUBULAR DEADBOLT

3" Smart Tubular Dead bolt

Base Material: Zinc  
Sold with matching wood screws.

Dimensions:  
Case Size: 70x20mm  
Backset: 57mm  
Keep: Yes  
Faceplate: 25mm

Finishes:  
MB, PC, SC



SC

#### Finishes:



MATT BLACK  
(MB)



POLISHED CHROME  
(PC)



SATIN CHROME  
(SC)

Smart latches and deadbolts are designed to reduce fitting time and improve the visual aesthetics of a latch. They can be fitted within a third of the time of a normal standard latch in 3 easy steps.

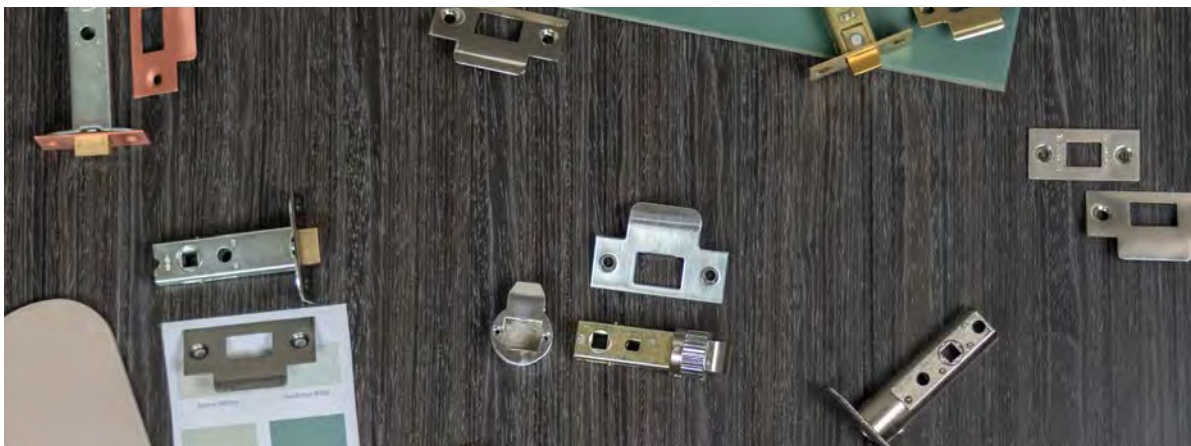

# REBATE KITS

Accessories | REBATE KITS

## ALREBCE(finish) REBATE KIT FOR CE TUBULAR LATCH

Rebate Kit for CE Certifire Bolt Through Tubular Latch Only

Base Material: Zinc Body, Mild Steel Faceplate  
 Sold with matching wood screws.  
 Dimensions:  
 Length/Width: 57mm/25mm  
 Depth: 13mm

Finishes:  
 AB, AC, BN, DS, MAB, MB, MBN, PB, PC,  
 PN, SB, SC, SN, UB, UDB, USC



UB

### Finishes:



## ALKREBS3LK(finish) REBATE KIT FOR 3 LEVER SASHLOCK

Atlantic 3 Lever Sashlock Rebate Kit

Base Material: Zinc  
 Sold with matching wood screws.  
 Dimensions:  
 Length/Width: 162mm/23.5mm  
 Depth: 15mm

Finishes:  
 AB, AC, BN, DS, MAB, MB, MBN, PB, PC, PN, SB, SC, SN, UDB, USC



USC

### Finishes:



## ALKREBSE(finish) REBATE KIT FOR EURO SASHLOCK

Atlantic Euro Sashlock Rebate Kit for 45mm+ doors

Base Material: Zinc  
 Sold with matching wood screws.  
 Dimensions:  
 Length/Width: 189mm/30mm  
 Depth: 13mm

Finishes:  
 AB, BN, MB, PC, SC



BN

### Finishes:



# MORTICE LOCKS

Accessories | BATHROOM LOCK

For unsprung door furniture, we recommend using our AL latches and ADB deadbolts rather than bathroom locks as these have a heavy duty dual spring which will operate unsprung door furniture better.

## ALKBATH25(FINISH) 2.5" UKCA CE ATLANTIC BATHROOM LOCK

2.5" CE Certifire Bolt Through Bathroom Lock - FD30/60  
 \*TO BE COMPLIANT MUST BE USED WITH INTUMESCENTS - PAGE 247-248

Base Material: Pressed Steel  
 Sold with matching wood screws.  
 Dimensions:  
 Backset: 45mm  
 Faceplate Size: 152x22mm  
 Dust Box: Yes

Finishes:  
 AB, AC, BN, DS, MAB, MB, MBN, PB,  
 PC, PN, SB, SC, SN, UB, UDB, USC

**RADIUS CORNER OPTIONS**  
 ALKRCBATH25(finish)  
 BN, MB, PB, PN, SB, SC, SN, UB



### Finishes:



## ALKBATH3(finish) 3" UKCA CE ATLANTIC BATHROOM LOCK

3" CE Certifire Bolt Through Bathroom Lock - FD30/60  
 \*TO BE COMPLIANT MUST BE USED WITH INTUMESCENTS - PAGE 247-248

Base Material: Pressed Steel  
 Sold with matching wood screws.  
 Dimensions:  
 Backset: 57mm  
 Faceplate Size: 152x22mm  
 Dust Box: Yes

Finishes:  
 AB, AC, BN, DS, MAB, MB, MBN, PB, PC, PN, SB, SC, SN, UB, UDB, USC

**RADIUS CORNER OPTIONS**  
 ALKRCBATH3(finish)  
 BN, MB, PB, PN, SB, SC, SN, UB

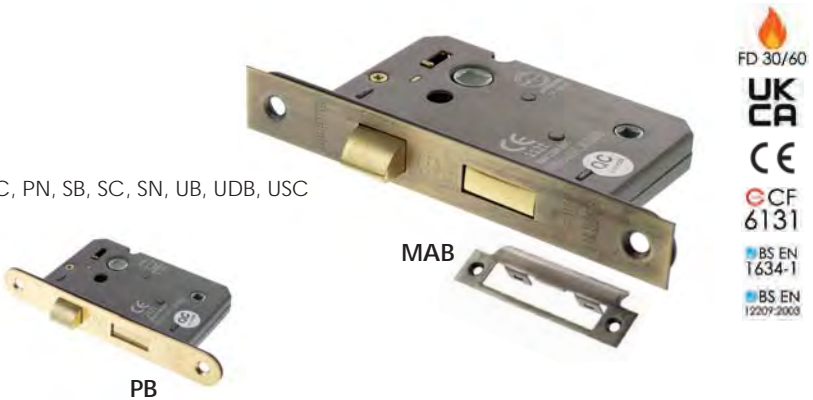

### Finishes:





# MORTICE LOCKS

## Accessories | 3 LEVER SASHLOCK

### ALKSASH3LK25(finish) 2.5" UKCA CE ATLANTIC 3 LEVER KEY SASHLOCK

2.5" CE Certifire Bolt Through 3 Lever Key Sashlock - FD30/60  
 \*TO BE COMPLIANT MUST BE USED WITH INTUMESCENTS - PAGE 247-248

Base Material: Pressed Steel  
 Sold with matching wood screws.

Dimensions:  
 Backset: 45mm  
 Faceplate Size: 152x22mm  
 Dust Box: Yes

Finishes:  
 AB, AC, BN, DS, MAB, MB, MBN, PB, PC, PN, SB, SC, SN, UB, UDB, USC



#### Finishes:



### ALKSASH3LK3(finish) 3" UKCA CE ATLANTIC 3 LEVER KEY SASHLOCK

3" CE Certifire Bolt Through 3 Lever Key Sashlock - FD30/60  
 \*TO BE COMPLIANT MUST BE USED WITH INTUMESCENTS - PAGE 247-248

Base Material: Pressed Steel  
 Sold with matching wood screws.

Dimensions:  
 Backset: 57mm  
 Faceplate Size: 152x22mm  
 Dust Box: Yes

Finishes:  
 AB, AC, BN, DS, MAB, MB, MBN, PB, PC, PN, SB, SC, SN, UB, UDB, USC



#### Finishes:



## Accessories | EURO SASHLOCK

### ALKSASHE25(finish) 2.5" UKCA CE ATLANTIC EURO SASHLOCK

2.5" CE Certifire Bolt Through Euro Sashlock - FD30/60  
 \*TO BE COMPLIANT MUST BE USED WITH INTUMESCENTS - PAGE 247-248

Base Material: Pressed Steel  
 Sold with matching wood screws.  
 Does not include Euro Cylinder.

Dimensions:  
 Backset: 45mm  
 Faceplate Size: 155x25mm  
 Dust Box: Yes

Finishes:  
 AB, AC, BN, DS, MAB, MB, MBN, PB, PC, PN, SB, SC, SN, UB, UDB, USC



#### ALKRSASHE25(finish) RADIUS CORNER OPTIONS:

MB, PB, PN, SC, SN

#### Finishes:



# MORTICE LOCKS

## Accessories | EURO SASHLOCK

### ALKSASHE3(finish) 3" UKCA CE ATLANTIC EURO SASHLOCK

3" CE Certifire Bolt Through Euro Sashlock - FD30/60  
 \*TO BE COMPLIANT MUST BE USED WITH INTUMESCENTS - PAGE 247-248

Base Material: Pressed Steel  
 Sold with matching wood screws.  
 Does not include Euro Cylinder.  
 Dimensions:  
 Backset: 57mm  
 Faceplate Size: 155x25mm  
 Dust Box: Yes

Finishes:  
 AB, AC, BN, DS, MAB, MB, MBN, PB, PC, PN, SB, SC, SN, UB, UDB, USC

#### RADIUS CORNER OPTIONS

ALKRCSASHE3(finish)  
 MB, PB, PN, SC, SN

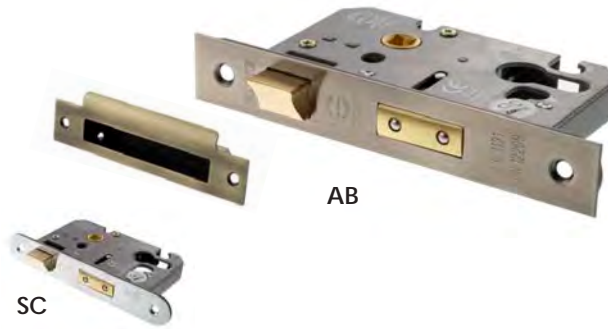

#### Finishes:



## Accessories | 5 LEVER SASHLOCK

### ALKSASH5LK25(finish) 2.5" ATLANTIC 5 LEVER KEY SASHLOCK

2.5" Bolt Through 5 Lever Key Sashlock - BRITISH STANDARD - BS3621

Base Material: Pressed Steel  
 Sold with matching wood screws.  
 Dimensions:  
 Backset: 45mm  
 Faceplate Size: 155x25mm  
 Dust Box: Yes

Finishes:  
 AB, DS, MB, PB, PC, SC, UB

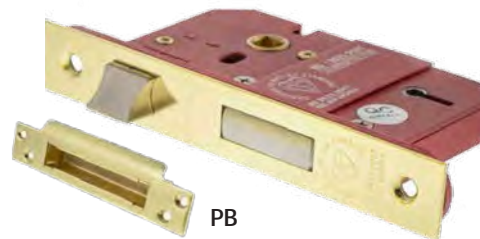

#### Finishes:



### ALKSASH5LK3(finish) 3" ATLANTIC 5 LEVER KEY SASHLOCK

3" Bolt Through 5 Lever Key Sashlock - BRITISH STANDARD - BS3621

Base Material: Pressed Steel  
 Sold with matching wood screws.  
 Dimensions:  
 Backset: 57mm  
 Faceplate Size: 155x25mm  
 Keep with Dust Box: Yes

Finishes:  
 AB, DS, MB, PB, PC, SC, UB



#### Finishes:



# MORTICE LOCKS

## Accessories | 3 LEVER DEADLOCK

### ALKDEAD3LK25(finish) 2.5" UKCA CE ATLANTIC 3 LEVER KEY DEADLOCK

2.5" CE Certifire 3 Lever Key Deadlock - FD30/60  
 \*TO BE COMPLIANT MUST BE USED WITH INTUMESCENTS - PAGE 247-248

Base Material: Pressed Steel  
 Sold with matching wood screws.  
 Dimensions: Backset: 45mm  
 Faceplate Size: 120x22mm  
 Dust Box: Yes



Finishes:  
 AB, AC, BN, DS, MAB, MB, MBN, PB, PC, PN, SB, SC, SN, UB, UDB, USC

#### Finishes:



### ALKDEAD3LK3(finish) 3" UKCA CE ATLANTIC 3 LEVER KEY DEADLOCK

3" CE Certifire 3 Lever Key Deadlock - FD30/60  
 \*TO BE COMPLIANT MUST BE USED WITH INTUMESCENTS - PAGE 247-248

Base Material: Pressed Steel  
 Sold with matching wood screws.  
 Dimensions: Backset: 57mm  
 Faceplate Size: 120x22mm  
 Dust Box: Yes



Finishes:  
 AB, AC, BN, DS, MAB, MB, MBN, PB, PC, PN, SB, SC, SN, UB, UDB, USC

#### Finishes:



## Accessories | EURO DEADLOCK

### ALKDEADE25(finish) 2.5" UKCA CE ATLANTIC EURO DEADLOCK

2.5" CE Certifire Bolt Through Euro Deadlock - FD30/60  
 \*TO BE COMPLIANT MUST BE USED WITH INTUMESCENTS - PAGE 247-248

Base Material: Pressed Steel  
 Sold with matching wood screws.  
 Does not include Euro Cylinder.  
 Dimensions:  
 Backset: 45mm  
 Faceplate Size: 125x25mm  
 Dust Box: Yes

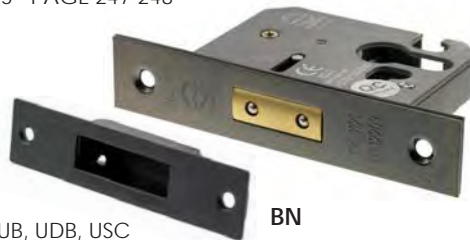

Finishes:  
 AB, AC, BN, DS, AB, MB, MBN, PB, PC, PN, SB, SC, SN, UB, UDB, USC

#### Finishes:



# MORTICE LOCKS

## Accessories | EURO DEADLOCK

### ALKDEADE3(finish) 3" UKCA CE ATLANTIC EURO DEADLOCK

3" CE Certifire Bolt Through Euro Deadlock - FD30/60  
 \*TO BE COMPLIANT MUST BE USED WITH INTUMESCENTS - PAGE 247-248  
 Base Material: Pressed Steel  
 Sold with matching wood screws.  
 Does not include Euro Cylinder.  
 Dimensions:  
 Backset: 57mm  
 Faceplate Size: 125x25mm  
 Dust Box: Yes

Finishes:  
 AB, AC, BN, DS, MAB, MB, MBN, PB, PC,  
 PN, SB, SC, SN, UB, UDB, USC



#### Finishes:



## Accessories | 5 LEVER DEADLOCK

### ALKDEAD5LK25(finish) 2.5" ATLANTIC 5 LEVER KEY DEADLOCK

2.5" 5 Lever Key Deadlock- BRITISH STANDARD - BS3621  
 Base Material: Pressed Steel  
 Sold with matching wood screws.  
 Dimensions:  
 Backset: 45mm  
 Faceplate Size: 125x25mm  
 Dust Box: Yes

Finishes:  
 AB, DS, MB, PB, PC, SC, UB



#### Finishes:



### ALKDEAD5LK3(finish) 3" ATLANTIC 5 LEVER KEY DEADLOCK

3" 5 Lever Key Deadlock- BRITISH STANDARD - BS3621  
 Base Material: Pressed Steel  
 Sold with matching wood screws.  
 Dimensions:  
 Backset: 57mm  
 Faceplate Size: 125x25mm  
 Dust Box: Yes

Finishes:  
 AB, DS, MB, PB, PC, SC, UB



#### Finishes:



# MORTICE LOCKS

## Accessories | HORIZONTAL SASHLOCKS

### ALKHZS(finish) 6" ATLANTIC HORIZONTAL 3 LEVER SASHLOCK

Base Material: Steel  
 Sold with matching wood screws.  
 Dimensions:  
 Backset: 127mm  
 Faceplate Size: 26x120mm  
 Dust Box: Yes

Finishes:  
 AB, AC, BN, DS, MAB, MB, MBN, PB,  
 PC, PN, SB, SC, SN, UDB, USC



#### Finishes:



## Accessories | HORIZONTAL BATHROOM LOCKS

### ALKHZB(finish) 6" ATLANTIC HORIZONTAL BATHROOM LOCK

Base Material: Steel  
 Sold with matching wood screws.  
 Dimensions:  
 Backset: 127mm  
 Faceplate Size: 26x120mm  
 Dust Box: Yes

Finishes:  
 AB, AC, BN, DS, MAB, MB, MBN, PB,  
 PC, PN, SB, SC, SN, UDB, USC

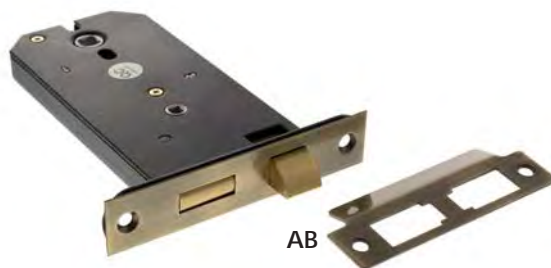

#### Finishes:



# DIN LOCKS

## Accessories | DIN SASHLOCK

- High-quality, heavy-duty.
- Latch tested to 200,000 cycles.
- Dead bolt tested to 50,000 cycles.
- The standard size of lock case means doors can be cut out in advance to one size and every lock type will work in the cut out.
- Fire rated FD20/30/60/90/120 with compatible intumescent available.
- For use in a high use area such as public buildings and schools.

### ALKDINES60(finish) ATLANTIC DIN EURO PROFILE SASHLOCK DOUBLE THROW 60MM BACKSET

Base Material: Stamped Steel  
 Dimensions:  
 Depth: 88mm  
 Height: 165mm  
 Width: 25mm  
 Faceplate: 25x235mm

Finishes: (Fixed Faceplate)  
 PSS, SSS

Finishes: (Detachable Faceplate)  
 AB, BN, MAB, MB, MBN, PC, SB, SC, UDB



EN  
1634



#### Finishes:



### ALKDINRES60(finish) ATLANTIC DIN RADIUS EURO PROFILE SASHLOCK DOUBLE THROW 60MM BACKSET

Base Material: Stamped Steel  
 Dimensions:  
 Depth: 88mm  
 Height: 165mm  
 Width: 25mm  
 Faceplate: 25x235mm

Finishes: (Fixed Faceplate)  
 PSS, SSS

Finishes: (Detachable Faceplate)  
 AB, BN, MAB, MB, MBN, PC, SB, SC, UDB



EN  
1634



#### Finishes:



## LARGEST RANGE OF DIN LOCK FINISHES AVAILABLE

ANTIQUÉ BRASS  
 BLACK NICKEL  
 MATT ANTIQUÉ BRASS  
 MATT BLACK

MATT GUN METAL  
 POLISHED CHROME  
 POLISHED STAINLESS STEEL  
 SATIN BRASS

SATIN CHROME  
 SATIN STAINLESS STEEL  
 URBAN DARK BRONZE



# DIN LOCKS

Accessories | DIN BATHROOM LOCK

## ALKDINB60(finish) ATLANTIC DIN BATHROOM LOCK DOUBLE TURN 60MM BACKSET

Base Material: Stamped Steel  
 Dimensions:  
 Depth: 88mm  
 Height: 165mm  
 Width: 25mm  
 Faceplate: 25x235mm

Finishes:  
 AB, BN, MAB, MB, MBN,  
 PC, PSS, SB, SC, SSS, UDB

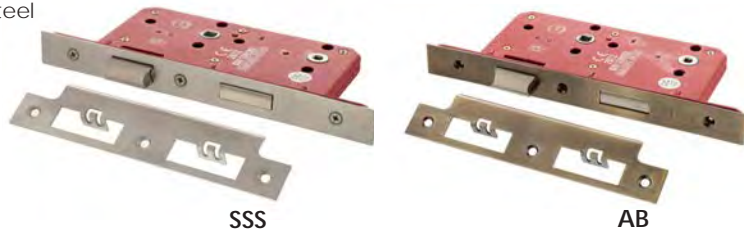

EN  
1634



### Finishes:



## ALKDINRB60(finish) ATLANTIC DIN RADIUS BATHROOM LOCK DOUBLE TURN 60MM BACKSET

Base Material: Stamped Steel  
 Dimensions:  
 Depth: 88mm  
 Height: 165mm  
 Width: 25mm  
 Faceplate: 25x235mm

Finishes:  
 AB, BN, MAB, MB, MBN,  
 PC, PSS, SB, SC, SSS, UDB

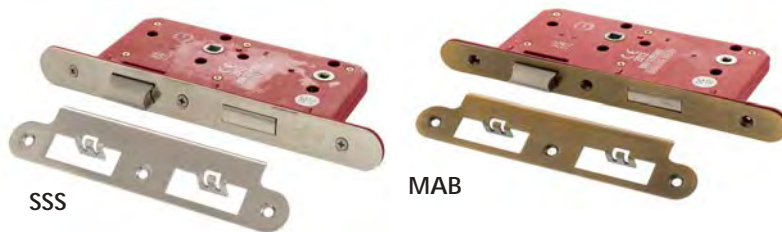

EN  
1634



### Finishes:



# DIN LOCKS

## Accessories | DIN LATCH

### ALKDINL60(finish) ATLANTIC DIN LATCH 60MM BACKSET

Base Material: Stamped Steel  
 Dimensions:  
 Depth: 88mm  
 Height: 165mm  
 Width: 25mm  
 Faceplate: 25x235mm

Finishes: (Fixed Faceplate)  
 PSS, SSS

Finishes: (Detachable Faceplate)  
 AB, BN, MAB, MB, MBN, PC, SB, SC, UDB



EN 1634



UK  
 CA  
 CE

#### Finishes:



### ALKDINRL60(finish) ATLANTIC DIN RADIUS LATCH 60MM BACKSET

Base Material: Stamped Steel  
 Dimensions:  
 Depth: 88mm  
 Height: 165mm  
 Width: 25mm  
 Faceplate: 25x235mm

Finishes: (Fixed Faceplate)  
 PSS, SSS

Finishes: (Detachable Faceplate)  
 AB, BN, MAB, MB, MBN, PC, SB, SC, UDB

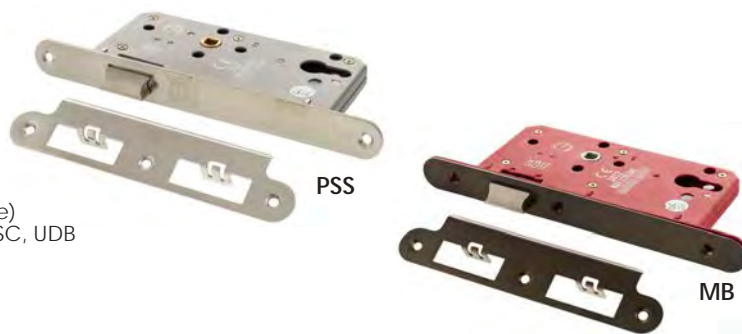

EN 1634



UK  
 CA  
 CE

#### Finishes:





# DIN LOCKS

## Accessories | DIN DEADLOCKS

### ALKDINED60(finish) ATLANTIC DIN EURO PROFILE DEADLOCK DOUBLE THROW 60MM BACKSET

Base Material: Stamped Steel  
 Dimensions:  
 Depth: 88mm  
 Height: 165mm  
 Width: 25mm  
 Faceplate: 25x235mm

Finishes: (Fixed Faceplate)  
 PSS, SSS

Finishes: (Detachable Faceplate)  
 AB, BN, MAB, MB, MBN, PC, SB, SC, UDB



EN  
1634



#### Finishes:



### ALKDINRED60(finish) ATLANTIC DIN RADIUS EURO PROFILE DEADLOCK DOUBLE THROW 60MM BACKSET

Base Material: Stamped Steel  
 Dimensions:  
 Depth: 88mm  
 Height: 165mm  
 Width: 25mm  
 Faceplate: 25x235mm

Finishes: (Fixed Faceplate)  
 PSS, SSS

Finishes: (Detachable Faceplate)  
 AB, BN, MAB, MB, MBN, PC, SB, SC, UDB



EN  
1634



#### Finishes:



## Accessories | DIN NIGHT LATCH

### ALKDINNL60(finish) ATLANTIC DIN NIGHT LATCH

Base Material: Stamped Steel  
 Dimensions:  
 Depth: 88mm  
 Height: 165mm  
 Width: 25mm  
 Faceplate: 25x235mm

Finishes: (Fixed Faceplate)  
 PSS, SSS

Finishes: (Detachable Faceplate)  
 MB



EN  
1634



#### Finishes:



# DIN LOCKS

## Accessories | DIN ESCAPE SASHLOCK

### ALKDINESCS60SSS ATLANTIC DIN EURO PROFILE ESCAPE SASHLOCK DOUBLE THROW WITH RTD LEVER 60MM BACKSET - SATIN STAINLESS STEEL

Base Material: Stamped Steel  
 Dimensions:  
 Depth: 88mm  
 Height: 166mm  
 Width: 25mm  
 Faceplate: 25x235mm

Finishes: (Fixed Faceplate)  
 ALKDINESCS60SSS



SSS

EN  
1634



UK  
CA  
CE

### ALKDINRESCS60SSS ATLANTIC DIN RADIUS EURO PROFILE ESCAPE SASHLOCK DOUBLE THROW WITH RTD LEVER 60MM BACKSET - SATIN STAINLESS STEEL

Base Material: Stamped Steel  
 Dimensions:  
 Depth: 88mm  
 Height: 166mm  
 Width: 25mm  
 Faceplate: 25x235mm

Finishes: (Fixed Faceplate)  
 ALKDINRESCS60SSS



SSS

EN  
1634



UK  
CA  
CE

## Accessories | DIN REBATE KIT

### ALKDINREB(FINISH) ATLANTIC REBATE KITS FOR DIN EURO PROFILE, BATHROOM LOCK, LATCH, EURO DEADLOCK

Base Material: Stamped Steel  
 Dimensions:  
 Length: 265mm  
 Width: 45mm  
 Depth: 16mm

Finishes:  
 AB, BN, MAB, MB, MBN, PC, PSS, SB, SC, SSS, UDB



UDB

EN  
1634



UK  
CA  
CE

#### Finishes:



## Accessories | DIN INTUMESCENT KIT

### ALKINTDINFD30 DIN LOCK INTUMESCENT LOCK KIT DIN Intumescent Lock Kit 1mm - FD30

Suitable for all Atlantic DIN locks.

### ALKINTDINFD60 DIN LOCK INTUMESCENT LOCK KIT DIN Intumescent Lock Kit 2mm - FD60

Suitable for all Atlantic DIN locks.

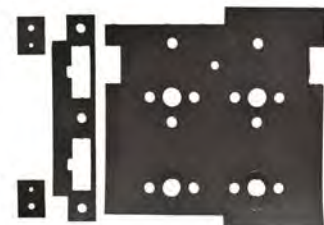



**Made in Italy.**

All products are manufactured in AGB's five Italian factories.

**Innovation & Technology.**

Technological excellence resulting in high quality products.

**Designed solutions.**

AGB products are technologically advanced yet beautiful too. The design of each item is minimalistic, clear and linear.

**CYLINDERS**

Passed strict testing.  
Extremely high durability.  
Finishes available.



ACCESSORIES



**CONCEALED HINGES**

Minimalistic look hinges.  
Easy to install.  
Suitable for many applications.



**MAGNETIC LOCKS**

Silent.  
Snap-in installation.  
Elegance - Hidden fixings.

# MAGNETIC LOCKS



## Accessories | AGB MAGNETIC BATHROOM LOCK

### AGB2XTWC(finish) AGB POLARIS 2XT MAGNETIC 60 / 50MM BACKSET BATHROOM LOCK

Italian Magnetic Bolt Through Bathroom Lock with Adjustable Strike Plate

Base Material: Zamak, Steel  
(This product could also be used as a standard latch)

Dimensions:  
Backset: 60mm / 50mm (AB & B only)  
Case Height: 132mm  
Case Thickness: 14mm  
Faceplate Size: 196mm X 18mm  
Centre to Centre: 96mm  
Fixed Faceplate  
Strike Plate:  
WC hole: 6mm (reducer included for 5mm spindles)  
H: 112mm W: 24mm D: 15mm  
EASY-FIX Strike Plate:  
H: 82mm W: 22mm D: 15.5mm

Finishes:  
60mm Backset & Standard strike plate:  
MB, PB, PC, SC, WH  
50mm Backset & EASY-FIX strike plate:  
AB, B

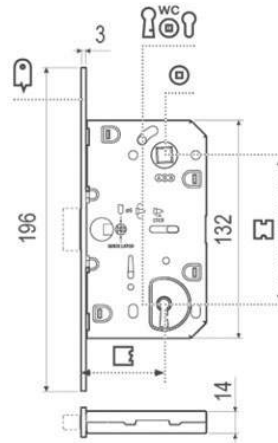

#### Finishes:



## Accessories | AGB MAGNETIC EURO SASHLOCK

### AGB2XTE(finish) AGB POLARIS XT MAGNETIC EURO PROFILE 60 / 50MM BACKSET SASHLOCK

Italian Magnetic Bolt Through Sashlock with Adjustable Strike Plate

Base Material: Zamak, Steel  
(This product could also be used as a standard latch)

Dimensions:  
Backset: 60mm / 50mm (AB & B only)  
Case Height: 132mm  
Case Thickness: 14mm  
Faceplate Size: 196mm X 18mm  
Centre to Centre: 85mm  
Fixed Faceplate  
Strike Plate:  
H: 112mm W: 24mm D: 15mm  
EASY-FIX Strike Plate:  
H: 82mm W: 22mm D: 15.5mm

Finishes:  
60mm Backset & Standard strike plate:  
MB, PB, PC, SC, WH  
50mm Backset & EASY-FIX strike plate:  
AB, B

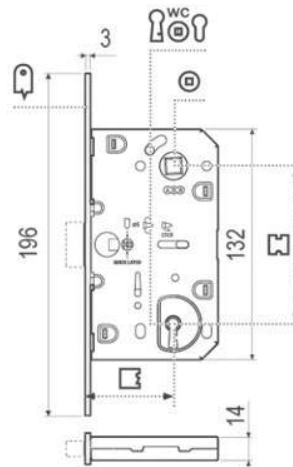

#### Finishes:



# MAGNETIC LOCKS



## Accessories | AGB MAGNETIC EURO SASHLOCK

The AGB range of **magnetic locks** includes some of the most advanced technological innovations the world of magnetic locks has ever seen!

Thanks to the practical **snap-in** installation of the forend, it is possible to hide the fastening screws of these magnetic locks, giving more **elegance** to the door! These smart magnetic locks also win against the most difficult weather conditions!

### AGBMLWC(finish) AGB REVOLUTION XT MAGNETIC 60MM BACKSET BATHROOM LOCK

Italian Magnetic Bolt Through Bathroom Lock - 60mm Backset. No visible screws for a modern seamless look.

Base Material: Zamak, Steel  
Sold with matching wood screws.  
(This product is also used as a standard latch)

Dimensions:  
Backset: 60mm  
Case Height: 132mm  
Case Thickness: 14mm  
Faceplate Size: 196mm X 18mm  
Adjustable Keep plate: Yes  
Centre to Centre: 96mm  
Faceplate is removable  
Non-handed.  
WC hole: 6mm (reducer included for 5mm spindles)

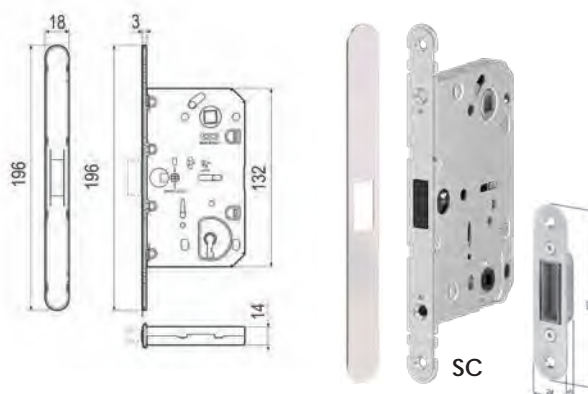

Finishes:  
MB, PC, SC

Finishes:



MATT BLACK (MB)

POLISHED CHROME (PC)

SATIN CHROME (SC)

## Accessories | AGB MAGNETIC EURO SASHLOCK

### AGBMLE(finish) AGB REVOLUTION XT MAGNETIC EURO PROFILE 60MM BACKSET SASHLOCK

Italian Magnetic Bolt Through Sashlock - 60mm Backset. No visible screws for a modern seamless look.

Base Material: Zamak, Steel  
Sold with matching wood screws.  
(This product is also used as a standard latch)

Dimensions:  
Backset: 60mm  
Case Height: 132mm  
Case Thickness: 14mm  
Faceplate Size: 196mm X 18mm  
Adjustable Keep plate: Yes  
Centre to Centre: 85mm  
Faceplate is removable  
Non-handed.  
WC hole: 6mm (reducer included for 5mm spindles)



Finishes:  
MB, PC, SC

Finishes:



MATT BLACK (MB)

POLISHED CHROME (PC)

SATIN CHROME (SC)

# MAGNETIC LOCKS



## Accessories | AGB MAGNETIC NARROW LOCKS - BATHLOCK & SASHLOCK

### AGB2XT25WC(finish) AGB POLARIS 2XT MAGNETIC 35MM Backset BATHROOM LOCK

Italian Magnetic Bolt Through Bathroom Lock  
Suitable for narrow stile doors.

Base Material: Zamak, Steel  
(This product could also be used as a standard latch)

Dimensions:  
Backset: 35mm  
Lock Depth: 61mm  
Case Height: 132mm  
Case Thickness: 14mm  
Faceplate Size: 196mm X 18mm  
Centre to Centre: 96mm  
Fixed Faceplate  
WC hole: 6mm (reducer included for 5mm spindles)

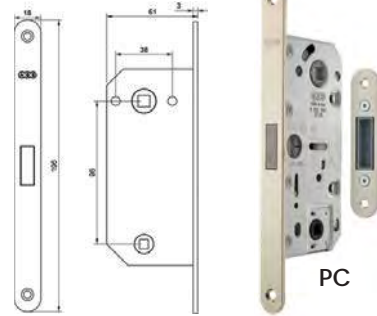

Finishes:  
MB, PC

Finishes:

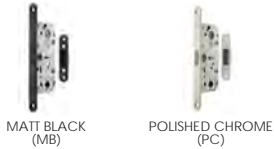

### AGB2XT25E(finish) AGB POLARIS 2XT MAGNETIC EURO PROFILE 35MM Backset SASHLOCK

Italian Magnetic Bolt Through Euro Profile Sashlock 35 mm backset  
Suitable for narrow stile doors.

Base Material: Zamak, Steel  
(This product could also be used as a standard latch)

Dimensions:  
Backset: 35mm  
Lock Depth: 60mm  
Case height: 132mm  
Case thickness: 14mm  
Faceplate Size: 196mm X 18mm  
Centre to Centre: 85mm  
Fixed Faceplate

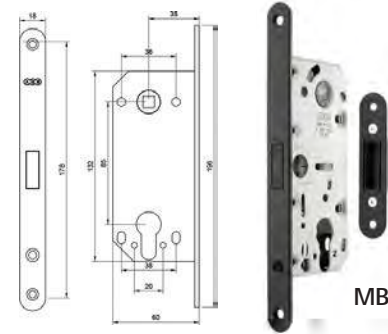

Finishes:  
MB, PC

Finishes:

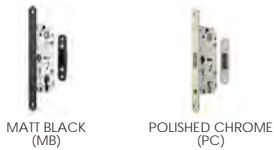

## Accessories | AGB MAGNETIC TUBULAR LATCH

### ML3(finish) 3" MAG-LATCH MAGNETIC TUBULAR LATCH

3" Silent Bolt Through Magnetic Tubular Latch

Base Material: Zinc  
Sold with matching wood screws.

Dimensions:  
Total Length: 86mm  
Backset: 60mm  
Faceplate Size: 65mm X 25mm  
Keep with Dust Box: Yes  
Keep Size: 65mm X 25mm



MB

Finishes:  
MB, PC, SN

Finishes:



# MAGNETIC LOCKS



## Accessories | AGB TOUCH MAGNETIC DOOR CATCHES

The perfect choice for modern and minimalist interiors. On the push side, Touch allows the door to be simply pushed open. On the other side, just pull with whatever handle or pull is fitted. Thanks to its patented adjustment system, Touch guarantees the door will close, even with a variable gap of 2 to 5mm between the sash and the striker.

The cover plate is removable and hides the fixing screws and the magnet adjusting grub screws. When the door is open, the magnet retracts and stays flush with the forend, giving a minimal design to the door and avoiding injury caused by protrusion.

### AGBT(finish) AGB TOUCH ADJUSTABLE MAGNETIC DOOR CATCHER

Open the door with the most simple and natural gesture: a touch!

Base Material: Zamak, Steel  
Dimensions:  
Case Height: 129mm  
Case Thickness: 14mm  
Faceplate Size: 196mm X 18mm  
Faceplate is removable

Finishes:  
MB, SC, WH



Finishes:



### AGBTE(finish) AGB TOUCH MAGNETIC DOOR CATCH EURO PROFILE SASHLOCK

Open the door with the most simple and natural gesture: a touch!

Base Material: Zamak, Steel  
Dimensions:  
Case Height: 132mm  
Case Thickness: 14mm  
Faceplate Size: 196mm X 18mm  
Faceplate is removable

Finishes:  
MB, SC, WH



Finishes:



### AGBTWC(finish) AGB TOUCH MAGNETIC DOOR CATCH BATHROOM

Open the door with the most simple and natural gesture: a touch!

Base Material: Zamak, Steel  
Dimensions:  
Case Height: 132mm  
Case Thickness: 15mm  
Faceplate Size: 196mm X 18mm  
Faceplate is removable  
WC hole: 8mm

Finishes:  
MB, SC, WH



Finishes:



# CYLINDERS

## Accessories | 5 PIN DOUBLE CYLINDER KEY TO KEY

### EXTREME PRECISION

Extreme precision and detail during manufacturing of these Cylinders ensures perfect functioning when opening and closing the door.

### A WARRANTY OF SECURITY

Cylinders are the first deterrent against a break-in attempt. AGB Cylinders provide the best technology to guarantee high security features protect your environment.

- High bumping resistance
- Hardened steel anti-drill pins
- U-shaped reinforcement

### AGB EURO PROFILE 5 PIN DOUBLE CYLINDER - KEY TO KEY - 30-30MM (60MM)

5 PIN Key to Differ Euro Cylinder - Key to Key.  
 Base Material: Brass  
 KEY TO DIFFER.  
 BS EN 1303:2015  
 3 Keys provided.  
 Dimensions: Total Length: 60mm

Finishes:

- C: C603022525
  - BN: C603F92525
  - MAB: C603722525
  - MB: C603842525
  - PB: C603012525
  - PC: C603302525
  - PN: C603062525
  - SB: C603082525
  - SC: C603322525
- Keyed Alike available.

B = 25mm  
 C = 25mm  
 X = 30mm  
 Y = 30mm



PB



FIRE DOOR  
 EN1634

EN 1634



5 PINS



ANTI-PULL  
 CAM



3 KEYS

Finishes:



### AGB EURO PROFILE 5 PIN DOUBLE CYLINDER - KEY TO KEY - 35-35MM (70MM)

5 PIN Key to Differ Euro Cylinder - Key to Key.  
 Base Material: Brass  
 KEY TO DIFFER.  
 BS EN 1303:2015  
 3 Keys provided.  
 Dimensions: Total Length: 70mm

Finishes:

- C: C603023030
  - BN: C603F93030
  - MAB: C603723030
  - MB: C603843030
  - PB: C603013030
  - PC: C603303030
  - PN: C603063030
  - SB: C603083030
  - SC: C603323030
- Keyed Alike available.

B = 30mm  
 C = 30mm  
 X = 35mm  
 Y = 35mm



MAB



FIRE DOOR  
 EN1634

EN 1634



5 PINS



ANTI-PULL  
 CAM



3 KEYS

Finishes:





# CYLINDERS



Accessories | 5 PIN KEY TO TURN



**1**  
5 Pins In Brass For  
The Coding

**2**  
Anti-Pull Cam In  
Sintered Steel

**3**  
3 Profile Keys

## AGB EURO PROFILE 5 PIN CYLINDER - KEY TO TURN - 30-30MM (60MM)

5 PIN Key to Differ Euro Cylinder - Key to Turn.

Base Material: Brass  
KEY TO DIFFER.  
BS EN 1303:2015  
3 Keys provided.

Dimensions:  
Total Length: 60mm

Finishes:  
C: C620022525  
BN: C620F92525  
MAB: C620722525  
MB: C620842525  
PB: C620012525  
PC: C620302525  
PN: C620062525  
SB: C620082525  
SC: C620322525

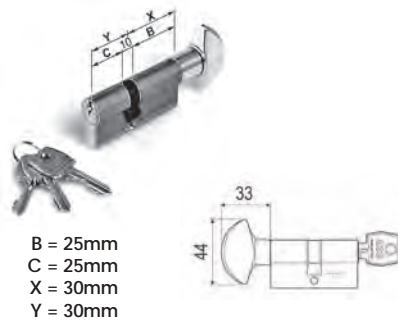

### Finishes:



## AGB EURO PROFILE 5 PIN CYLINDER - KEY TO TURN - 35-35MM (70MM)

5 PIN Key to Differ Euro Cylinder - Key to Turn.

Base Material: Brass  
KEY TO DIFFER.  
BS EN 1303:2015  
3 Keys provided.

Dimensions:  
Total Length: 70mm

Finishes:  
C: C620023030  
BN: C620F93030  
MAB: C620723030  
MB: C620843030  
PB: C620013030  
PC: C620303030  
PN: C620063030  
SB: C620083030  
SC: C620323030

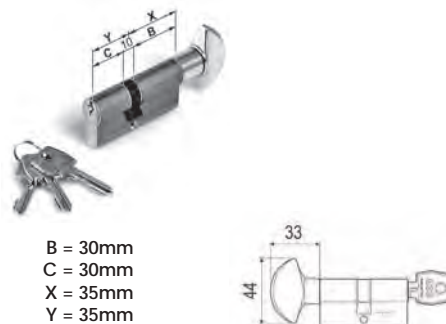

### Finishes:



# CYLINDERS

## Accessories | 5 PIN SINGLE CYLINDERS

### AUTOMATED ASSEMBLY

The dedicated cylinder manufacturing plant, the continuous investments in automation and the qualified staff, guarantee the AGB cylinders are expert pieces of hardware.

### AUTOMATIC TESTS

AGB cylinders have to pass strict tests and controls in every step of production. Automatic controls are so accurate that they can simulate the movement of the hand turning a key. Every AGB cylinder has been tested before it is packaged.

### AGB EURO PROFILE 5 PIN SINGLE CYLINDER - 10-30MM (40MM)

5 PIN Euro Half Cylinder - Key only.

Base Material: Brass  
KEY TO DIFFER.  
BS EN 1303:2015  
3 Keys provided.

Dimensions: Total Length: 40mm

Finishes:

C: C630020525  
BN: C630F90525  
MAB: C630720525  
MB: C630840525  
PC: C630300525  
SB: C630080525  
SC: C630320525



B = 5mm  
C = 25mm  
X = 10mm  
Y = 30mm



SB



FIRE DOOR  
EN1634



5  
PINS



ANTI-PULL  
CAM



3  
KEYS

Finishes:



COPPER  
(C)



BLACK NICKEL  
(BN)



MATT ANTIQUE BRASS  
(MAB)



MATT BLACK  
(MB)



POLISHED CHROME  
(PC)



SATIN BRASS  
(SB)



SATIN CHROME  
(SC)

### AGB EURO PROFILE 5 PIN SINGLE CYLINDER - 10-35MM (45MM)

5 PIN Euro Half Cylinder - Key only.

Base Material: Brass  
KEY TO DIFFER.  
BS EN 1303:2015  
3 Keys provided.

Dimensions: Total Length: 45mm

Finishes:

C: C630020530  
BN: C630F90530  
MAB: C630720530  
MB: C630840530  
PC: C630300530  
SB: C630080530  
SC: C630320530



B = 5mm  
C = 30mm  
X = 10mm  
Y = 35mm



SB



FIRE DOOR  
EN1634



5  
PINS



ANTI-PULL  
CAM



3  
KEYS

Finishes:



COPPER  
(C)



BLACK NICKEL  
(BN)



MATT ANTIQUE BRASS  
(MAB)



MATT BLACK  
(MB)



POLISHED CHROME  
(PC)



SATIN BRASS  
(SB)



SATIN CHROME  
(SC)

# CYLINDERS



## Accessories | 15 PIN KEY TO KEY CYLINDERS

### KEY FEATURES OF 15 PIN CYLINDERS

- Made in Italy
- 3 anti-drill steel pins on each side
- 6 active pins & 9 passive pins
- Anti-pull cam in sintered steel
- High resistance to bumping, certified (ICIM 7-R009)
- 5 flat reversible keys with long necks that are resistant to torsion
- Suitable for fire & smoke resistant doors
- Extremely high durability. Tested to EN 1303
- Extremely high resistance to thermal & climate stresses



### AGB EURO PROFILE 15 PIN DOUBLE CYLINDER - KEY TO KEY - 35-35MM (70MM)

15 PIN Key to Differ Euro Cylinder - Key to Key.

Base Material: Brass  
KEY TO DIFFER.  
BS EN 1303:2015  
5 Keys provided.

To suit a 45mm door.

Dimensions:  
Total Length: 70mm

Finishes:

C: CA00023030  
MAB: CA00723030  
MB: CA00843030  
PC: CA00303030  
SN: CA00163030  
SB: CA00083030  
SC: CA00323030



B = 30mm  
C = 30mm  
X = 35mm  
Y = 35mm



Finishes:



### AGB EURO PROFILE 15 PIN DOUBLE CYLINDER- KEY TO KEY - 40-40MM (80MM)

15 PIN Key to Differ Euro Cylinder - Key to Key.

Base Material: Brass  
KEY TO DIFFER.  
BS EN 1303:2015  
5 Keys provided.

To suit a 55mm door.

Dimensions:  
Total Length: 80mm

Finishes:

C: CA00023535  
MAB: CA00723535  
MB: CA00843535  
PC: CA00303535  
SN: CA00163535  
SB: CA00083535  
SC: CA00323535



B = 35mm  
C = 35mm  
X = 40mm  
Y = 40mm

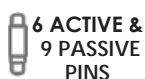
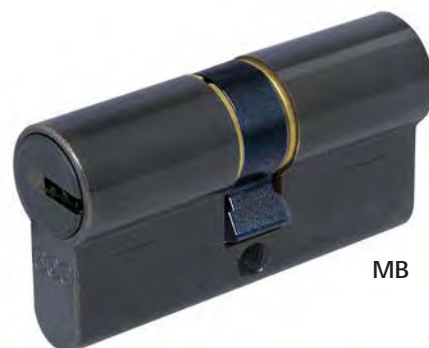

Finishes:



# CYLINDERS

Accessories | 15 PIN KEY TO TURN

## AGB EURO PROFILE 15 PIN CYLINDER - KEY TO TURN - 35-35MM (70MM)

15 PIN Key to Differ Euro Cylinder - Key to Turn.

Base Material: Brass  
KEY TO DIFFER.  
BS EN 1303:2015  
5 Keys provided.

Dimensions:  
Total Length: 70mm

Finishes:  
C: CA20023030  
MAB: CA20723030  
MB: CA20843030  
PC: CA20303030  
SN: CA20163030  
SB: CA20083030  
SC: CA20323030

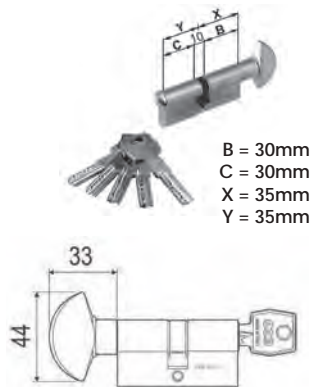

SC



FIRE DOOR  
EN1634

6 ACTIVE &  
9 PASSIVE  
PINS

ANTI-PULL  
CAM

ANTI-DRILL  
PINS

5  
KEYS

Finishes:



COPPER  
(C)



MATT ANTIQUE BRASS  
(MAB)



MATT BLACK  
(MB)



POLISHED CHROME  
(PC)



SATIN NICKEL  
(SN)



SATIN BRASS  
(SB)



SATIN CHROME  
(SC)

## AGB EURO PROFILE 15 PIN CYLINDER - KEY TO TURN - 40-40MM (80MM)

15 PIN Key to Differ Euro Cylinder - Key to Turn.

Base Material: Brass  
KEY TO DIFFER.  
BS EN 1303:2015  
5 Keys provided.

Dimensions:  
Total Length: 80mm

Finishes:  
C: CA20023535  
MAB: CA20723535  
MB: CA20843535  
PC: CA20303535  
SN: CA20163535  
SB: CA20083535  
SC: CA20323535

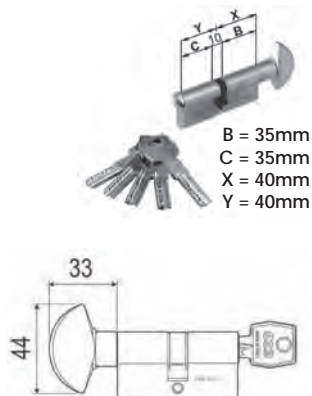

MB



FIRE DOOR  
EN1634

6 ACTIVE &  
9 PASSIVE  
PINS

ANTI-PULL  
CAM

ANTI-DRILL  
PINS

5  
KEYS

Finishes:



COPPER  
(C)



MATT ANTIQUE BRASS  
(MAB)



MATT BLACK  
(MB)



POLISHED CHROME  
(PC)



SATIN NICKEL  
(SN)



SATIN BRASS  
(SB)



SATIN CHROME  
(SC)

# CYLINDERS



## Accessories | 5 PIN KEYED ALIKE KEY TO KEY

### AGB EURO PROFILE 5 PIN DOUBLE CYLINDER KEYED ALIKE - KEY TO KEY - 30-30MM (60MM)

5 PIN Keyed Alike Euro Cylinder - Key to Key.

**KEYED ALIKE.**

Base Material: Brass  
 BS EN 1303:2015  
 3 Keys provided.  
 1 Version  
 Dimensions: Total Length: 60mm

**Finishes:**

C: C603022525KA  
 MAB: C603722525KA  
 MB: C603842525KA  
 PC: C603302525KA  
 SB: C603082525KA  
 SC: C603322525KA

Key to Differ available.

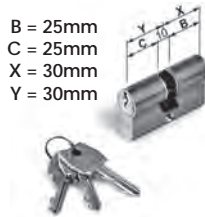

FIRE DOOR  
 EN1634



5  
 PINS



ANTI-PULL  
 CAM



3  
 KEYS

**Finishes:**



COPPER  
 (C)



MATT ANTIQUE BRASS  
 (MAB)



MATT BLACK  
 (MB)



POLISHED CHROME  
 (PC)



SATIN BRASS  
 (SB)



SATIN CHROME  
 (SC)

### AGB EURO PROFILE 5 PIN DOUBLE CYLINDER KEYED ALIKE - KEY TO KEY - 35-35MM (70MM)

5 PIN Keyed Alike Euro Cylinder - Key to Key.

**KEYED ALIKE.**

Base Material: Brass  
 BS EN 1303:2015  
 3 Keys provided.  
 1 Version  
 Dimensions: Total Length: 70mm

**Finishes:**

C: C603023030KA  
 MAB: C603723030KA  
 MB: C603843030KA  
 PC: C603303030KA  
 SB: C603083030KA  
 SC: C603323030KA

Keyed to Differ available.



FIRE DOOR  
 EN1634



5  
 PINS



ANTI-PULL  
 CAM



3  
 KEYS

**Finishes:**



COPPER  
 (C)



MATT ANTIQUE BRASS  
 (MAB)



MATT BLACK  
 (MB)



POLISHED CHROME  
 (PC)



SATIN BRASS  
 (SB)



SATIN CHROME  
 (SC)

ACCESSORIES

# CYLINDERS



Accessories | AGB CYLINDERS - KEY SYSTEMS

## AGB CYLINDER KEY SYSTEMS

Atlantic now offers a keyed-alike and master key cylinder service to our growing AGB Euro Cylinders range. This portfolio includes special finish focused offerings including Matt Antique Brass, Satin Brass, Copper, Matt Black and Black Nickel to name a few!

### Keyed Alike Cylinders

All cylinders in a set are designed to be opened by the same key. The key for each cylinder will work for the other cylinders in the set. This provides convenience for users as it allows multiple locks to be operated using a single key.

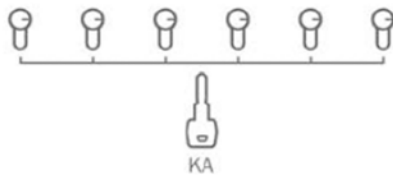

The quantity of cylinders per set/system is unlimited and down to customer preference.

### Master Key Cylinders

All cylinders in a set have their own unique key. In addition there is one master key that can unlock all the individual cylinders within the system.

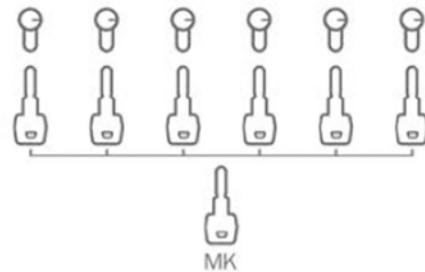

Sub master keys are also available on request.



**5 PIN DOUBLE CYLINDER**  
Each cylinder comes with 3 keys.  
Available in: BN, C, MAB, MB, PB, PC, PN, SB, SC



**5 PIN DOUBLE CYLINDER**  
Each cylinder comes with 3 keys.  
Available in: BN, C, MAB, MB, PB, PC, PN, SB, SC, BN



**5 PIN SINGLE CYLINDER**  
Each cylinder comes with 3 keys.  
Available in: C, MAB, MB, PB, PC, PN, SB, SC, BN



**15 PIN DOUBLE CYLINDER**  
Each cylinder comes with 5 keys.  
Available in: C, MAB, MB, PC, PN, SB, SC



**15 PIN KEY TO TURN CYLINDER**  
Each cylinder comes with 5 keys.  
Available in: C, MAB, MB, PC, PN, SB, SC



A small collection of regular sizes of 5 pin double cylinders are held in stock. All other variations including master key cylinders are made to order on a 6-8 week lead time.

# INTUMESCENTS

## Accessories | INTUMESCENT STRIP

### AFO(size)(finish) INTUMESCENT STRIP

Fire Only Intumescent Strip

Finishes:  
Brown (B)  
White (W)

Sizes:  
(10, 15, 20)x4mm X 2.1m  
10mm - AFO104B  
AFO104W  
15mm - AFO154B  
AFO154W  
20mm - AFO204B  
AFO204W



B

### AFS(size)(finish) INTUMESCENT STRIP

Fire & Smoke Intumescent Strip

Finishes:  
Brown (B)  
White (W)

Sizes:  
(10, 15, 20)x4mm X 2.1m  
10mm - AFS10421B  
AFS10421W  
15mm - AFS15421B  
AFS15421W  
20mm - AFS20421B  
AFS20421W  
15mmx4mmx1.05m (Pack of 5)  
AFS15410B(5)  
AFS15410W(5)



W

## Accessories | INTUMESCENT HINGE PAD

### AHPFR43(FD30/FD60) INTUMESCENT HINGE PAD

Intumescent Hinge Pad 4" x 3"

AHPFR43FD30 - Atlantic Intumescent Hinge Pad 4" x 3" - FD30  
AHPFR43FD60 - Atlantic Intumescent Hinge Pad 4" x 3" - FD60

Also available in a Pre-pack of 6:  
AHPFR43FD30(6) - Atlantic Intumescent Hinge Pad 4" x 3" set of 6 - FD30



(6)

### AHPFR32(FD30/FD60) INTUMESCENT HINGE PAD

Intumescent Hinge Pad 3" x 2"

AHPFR32FD30 - Atlantic Intumescent Hinge Pad 3" x 2" - FD30  
AHPFR32FD60 - Atlantic Intumescent Hinge Pad 3" x 2" - FD60

### AHPFRR43(FD30/FD60) RADIUS INTUMESCENT HINGE PAD

Radius Edge Intumescent Hinge Pad 4" x 3"

AHPFRR43FD30 - Atlantic Radius Corner Intumescent Hinge Pad 4"x3" - FD30  
AHPFRR43FD60(6) - Atlantic Radius Corner Intumescent Hinge Pad 4"x3" set of 6 - FD60



## Accessories | INTUMESCENT LATCH KITS

### ALINTFD30 INTUMESCENT LATCH KIT - 1MM - FD30

Intumescent Latch Kit 1mm - FD30

Suitable for ALCE25, ALCE3 and our CE deadbolts.

### ALINTFD60 INTUMESCENT LATCH KIT- 2MM - FD60

Intumescent Latch Kit 2mm - FD60

Suitable for ALCE25, ALCE3 our CE deadbolts.



# INTUMESCENTS

## Accessories | INTUMESCENT LOCK KITS

### WHY INTUMESCENT?

All ironmongery installed on a fire door must be fitted without compromising the integrity of the complete fire door assembly. This is particularly important when ironmongery is rebated into the doorset such as hinges, locks and latches. To ensure our CE Certifire latches, dead bolts, locks and hinges are compliant, intumescent kits or pads must be fitted. These kits are flexible and pre-made with cut out lines that can be tailored to the item they are being fitted with. Check the fire rating of the door and ensure you fit the appropriate intumescent protection.

#### ALKINTBATHFD30 BATHROOM LOCK INTUMESCENT LOCK KIT

Bathroom Lock Intumescent Lock Kit 1mm - FD30

Suitable for 2.5" & 3" Bathroom Locks.

#### ALKINTBATHFD60 BATHROOM LOCK INTUMESCENT LOCK KIT

Bathroom Lock Intumescent Lock Kit 2mm - FD60

Suitable for 2.5" & 3" Bathroom Locks.

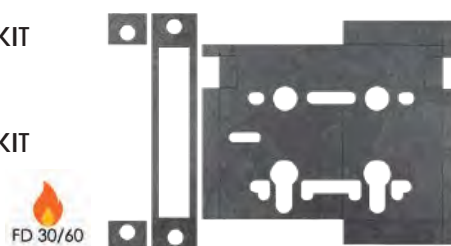

#### ALKINTDEAD3LKFD30 DEADLOCK INTUMESCENT LOCK KIT

3 Lever Deadlock Intumescent Lock Kit 1mm - FD30

Suitable for 3 Lever Dead Locks in 2.5" & 3".

#### ALKINTDEAD3LKFD60 DEADLOCK INTUMESCENT LOCK KIT

3 Lever Deadlock Intumescent Lock Kit 2mm - FD60

Suitable for 3 Lever Dead Locks in 2.5" & 3".

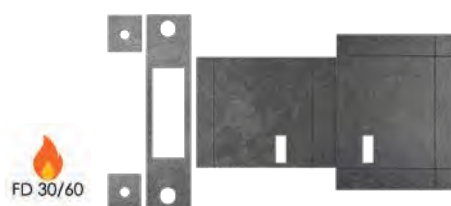

#### ALKINTDEADFD30 DEADLOCK INTUMESCENT LOCK KIT

Euro Deadlock Intumescent Lock Kit 1mm - FD30

Suitable for Euro Dead Locks & 5 Lever Dead Locks in 2.5" & 3".

#### ALKINTDEADFD60 DEADLOCK INTUMESCENT LOCK KIT

Euro Deadlock Intumescent Lock Kit 2mm - FD60

Suitable for Euro Dead Locks & 5 Lever Dead Locks in 2.5" & 3".

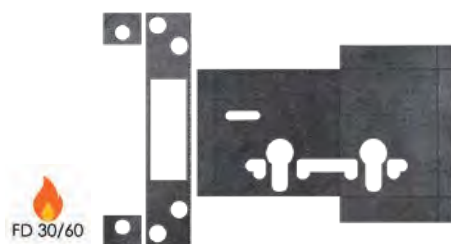

#### ALKINTSASHFD30 SASHLOCK INTUMESCENT LOCK KIT

Sashlock Intumescent Lock Kit 1mm - FD30

Suitable for 5 Lever, 3 Lever & Euro Profile Sash Locks in 2.5" & 3".

#### ALKINTSASHFD60 SASHLOCK INTUMESCENT LOCK KIT

Sashlock Intumescent Lock Kit 2mm - FD60

Suitable for 5 Lever, 3 Lever & Euro Profile Sash Locks in 2.5" & 3".

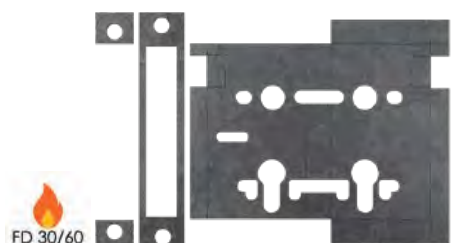

#### ALKINTDINFD30 DIN LOCK INTUMESCENT LOCK KIT

DIN Intumescent Lock Kit 1mm - FD30

Suitable for all Atlantic DIN locks.

#### ALKINTDINFD60 DIN LOCK INTUMESCENT LOCK KIT

DIN Intumescent Lock Kit 2mm - FD60

Suitable for all Atlantic DIN locks.





# DOOR STOPS

Accessories | DOOR STOPS

## ADSCP(finish) CYLINDER DOOR STOP

Cylinder Premium Solid Brass Floor Mounted Door Stop

Base Material: Solid Brass  
 Sold with matching wood screws.  
 Total Height: 38.5mm  
 Rubber Width: 35mm  
 Base Width: 32mm

Finishes:  
 AB, AC, BN, DS, MAB, MB, MBN, PB, PC, PN, SB, SC, SN, UB, UDB, USC



UB

Finishes:



## ADSHMP(finish) HALF-MOON DOOR STOP

Half-Moon Premium Solid Brass Floor Mounted Door Stop

Base Material: Solid Brass  
 Sold with matching wood screws.

Height from Base: 26mm  
 Diameter: 40mm

Finishes:  
 AB, AC, BN, DS, MAB, MB, MBN, PB, PC, PN, SB, SC, SN, UB, UDB, USC



UB

Finishes:



## ADSWP(finish) WALL DOOR STOP

Premium Skirting/Wall Mounted Door Stop on Concealed Fix Rose

Base Material:  
 Zinc (for finishes: AC, BN, DS, MB, MBN, PB, PC, PN, SC, SN, USC)  
 Brass (for finishes: AB, MAB, SB, UB)  
 Sold with matching wood screws.

Total Height: 83mm  
 Base Diameter: 32mm

Finishes:  
 AB, AC, BN, DS, MAB, MB, MBN, PB, PC, PN, SB, SC, SN, UB, USC



MB

Finishes:



# FLUSH BOLTS & HOOKS

## Accessories | FLUSH BOLTS

### AFB15019(finish) FLUSH BOLT

150mm x 19mm Solid Brass Lever Action Flush Bolt

Base Material: Solid Brass  
Sold with matching wood screws.

Length & Width: 150x19mm  
Shoot Bolt Dimensions: 11mm  
Maximum cut out depth: 25mm

Finishes:  
AB, AC, BN, DS, MAB, MB, MBN, PB, PC, PN, SB, SC, SN, UB, USC



#### Finishes:



### AFB(150/200)(19/25)(finish) FLUSH BOLT

Stainless Steel Lever Action Flush Bolt

Base Material: Stainless Steel  
Sold with matching wood screws.

Sizes:  
Length & Width: 200x19mm  
Length & Width: 200x25mm

Sizes & Finishes:  
MB, SSS, MB, SSS, MB



#### Finishes:



## Accessories | HOOKS

### AHCH(finish) HAT & COAT HOOK

Premium Traditional Solid Brass Hat & Coat Hook

Base Material: Solid Brass  
Sold with matching wood screws.

Total Height: 148mm

Finishes:  
AB, AC, BN, DS, MAB, MB, MBN, PB, PC, PN, SB, SC, SN, UB, USC



#### Finishes:

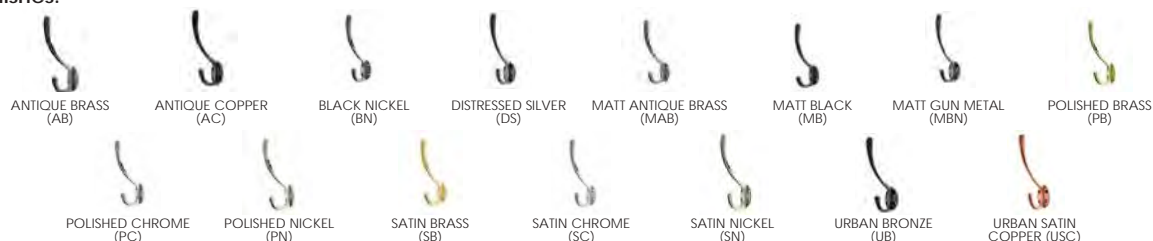

# BOLTS

## Accessories | BOLTS

### ASB(size)(finish) ATLANTIC SOLID BRASS SURFACE DOOR BOLT

High-quality durable finish focused Surface Bolts

Base Material: Solid Brass  
Sold with matching screws.

Sizes:  
4"  
6"  
8"

Finishes:  
AB, DS, MB, MBN, PC, PN, SB, SC, SN, UDB



Distressed Silver 4" (ASB4DS)



Satin Brass 6" (ASB6SB)



Matt Gun Metal 8" (ASB8MBN)

Finishes:



ANTIQUE BRASS (AB)



DISTRESSED SILVER (DS)



MATT BLACK (MB)



MATT GUN METAL (MBN)



POLISHED NICKEL (PN)



SATIN BRASS (SB)



SATIN NICKEL (SN)



URBAN DARK BRONZE (UDB)

### ARB(size)(finish) ATLANTIC RACK BOLT

Rack Bolts are door security bolts which are concealed within timber doors and are operated with a key or thumbturn.

Base Material: Solid Brass  
Sold in singles with screws.

31mm Backset:  
Faceplate: 20x43mm  
Bolt Body: 61x16mm

59mm Backset:  
Faceplate: 43x20mm  
Bolt Body: 88x16mm



Polished Chrome 31mm (ARB31PC)



Antique Brass 59mm (ARB59AB)

Finishes:  
AB, AC, BN, DS, MAB, MB, MBN, PB, PC, PN, SB, SC, SN, UDB, USC

Finishes:



ANTIQUE BRASS (AB)



ANTIQUE COPPER (AC)



BLACK NICKEL (BN)



DISTRESSED SILVER (DS)



MATT ANTIQUE BRASS (MAB)



MATT BLACK (MB)



MATT GUN METAL (MBN)



POLISHED BRASS (PB)



POLISHED CHROME (PC)



POLISHED NICKEL (PN)



SATIN BRASS (SB)



SATIN CHROME (SC)



SATIN NICKEL (SN)



URBAN DARK BRONZE (UDB)



URBAN SATIN COPPER (USC)

## Accessories | THUMBTURNS

### ARB(finish) ATLANTIC RACK BOLT OVAL THUMBTURN

Oval thumbturns in 15 finishes to go with Atlantic's door security Rack Bolts.

Base Material: Solid Brass  
Sold in singles with screws.

Oval Width: 30mm Oval Length: 20mm Projection 31mm

Finishes:  
AB, AC, BN, DS, MAB, MB, MBN, PB, PC, PN, SB, SC, SN, UB, USC



AB

### ARBKEY ATLANTIC RACK BOLT SPARE KEY

Finishes:



ANTIQUE BRASS (AB)



ANTIQUE COPPER (AC)



BLACK NICKEL (BN)



DISTRESSED SILVER (DS)



MATT ANTIQUE BRASS (MAB)



MATT BLACK (MB)



MATT GUN METAL (MBN)



POLISHED BRASS (PB)



POLISHED CHROME (PC)



POLISHED NICKEL (PN)



SATIN BRASS (SB)



SATIN CHROME (SC)



SATIN NICKEL (SN)



URBAN DARK BRONZE (UDB)



URBAN SATIN COPPER (USC)

# ACCESSORIES

## Accessories | ROLLER CATCHES

### ARCA(finish) ATLANTIC ADJUSTABLE ARCHITECTURAL ROLLER CATCH

A Roller Catch is a quick and easy fastening method for keeping doors closed.

With a simple push, it will click shut.

Heavy Duty

Sold in singles with screws.

Base Material: Stamped steel body, brass roller bolt,

Stainless steel faceplates.

Faceplate: 22x76mm

Catch Body: 50x33mm

Finishes:

AB, AC, BN, DS, MAB, MB, MBN, PB, PC, PN, SB, SC, SN, UDB, USC



Finishes:



## Accessories | DOOR GUARDS

### ADG(finish) ATLANTIC SECURITY DOOR GUARD

A Door Guard offers extra security to doors by blocking access when the guard is locked.

Sold in singles with screws.

Base Material: Die cast zinc

Height: 104mm

Width: 58.2mm

Depth: 19mm

Finishes:

AB, MB, PC, SC, UDB



Finishes:



## Accessories | HANDRAIL BRACKETS

### AHB80(finish) Atlantic Heavy-Duty Handrail Bracket 80mm Projection

The finishing touch to any bannister.

Sold in singles with screws.

Base Material: Zinc

Height: 80mm

Rose: 58mm

Finishes:

AB, MB, PC, SC



Finishes:



# LATCH PACKS

Accessories | LATCH PACKS

## ALP2532PN LATCH PACK - CE 2.5" LATCH & SPIN TIP CE GRADE 7 HINGES

ATLANTIC LATCH PACK CE 2.5" (LATCH X1) & 3"X2" (HINGE X 2)

FIRE RATED.  
Hinges Base Material: Mild Steel  
Sold with matching wood screws.

Finishes:  
PN



## ALP2532(finish) LATCH PACK - CE 2.5" LATCH & GRADE 7 CE BALL BEARING HINGES

ATLANTIC LATCH PACK CE 2.5" (LATCH X1) & 3"X2" (HINGE X 3)

FIRE RATED.  
Hinges Base Material: Mild Steel  
Sold with matching wood screws.

Finishes:  
AB, BN, MB, PC, SC, SB, UDB



Finishes:



## ALP332(finish) LATCH PACK - CE 3" LATCH & GRADE 7 CE BALL BEARING HINGES

ATLANTIC LATCH PACK CE 3" (LATCH X1) & 3"X2" (HINGE X 3)

FIRE RATED.  
Hinges Base Material: Mild Steel  
Sold with matching wood screws.

Finishes:  
AB, BN, MB, PC, SC, SB, UDB



Finishes:



# PROJECTS

From cabinet hardware to handles, hinges, and beyond, we love to see how our products are brought to life in your projects. Whether renovating a kitchen, bathroom, and even custom furniture projects, our hardware adds the perfect finishing touch. Explore the following pages to discover selection of our products, beautifully showcased in various settings, from contemporary to traditional spaces. Let these examples inspire your next project and show how our hardware can elevate any design with its quality craftsmanship and timeless appeal.

Be sure to follow us on our social media channels to stay updated with the latest product releases and design inspiration. We love seeing how our products are used in your projects, so don't forget to tag us in your photos and share your work with our community.



@atlantic  
handles



@atlantic  
handles



Atlantic UK  
Architectural  
Hardware



@atlantic  
ukTFM























# QUICK INDEX

A2H322(finish)	214	ALKBATH3(finish)	224	AS75FDKCASSS	197
A2HB32525(finish)	214	ALKBATH25(finish)	224	AS75FDKCLASSS	197
ACPc(size)(finish)	194	ALKDEAD3LK3(finish)	227	AS75FDKSASSS	197
ADB3(finish)	220	ALKDEAD3LK25(finish)	227	AS75MASSS	197
ADB4(finish)	220	ALKDEAD5LK3(finish)	228	AS75PULLASSS	197
ADB25(finish)	220	ALKDEAD5LK25(finish)	228	AS75PUSHSSS	197
ADBCE3(finish)	221	ALKDEADE3(finish)	228	AS75SASSS	197
ADBCE25(finish)	221	ALKDEADE25(finish)	227	AS75UASSS	197
ADBRCE3(finish)	221	ALKDINB60(finish)	231	AS75WCASSS	197
ADBRCE25(finish)	221	ALKDINED60(finish)	233	ASB(size)(finish)	251
ADC925MB	196	ALKDINES60(finish)	230	ASdb3(finish)	222
ADG(finish)	252	ALKDINESCS60SSS	234	ASL3(finish)	222
ADSCC(finish)	195	ALKDINL60(finish)	232	awcD(finish)	196
ADSCP(finish)	249	ALKDINNL60(finish)	233	awcr(finish)	196
ADSHMC(finish)	195	ALKDINRB60(finish)	231	AWH3222(finish)	216
ADSHMP(finish)	249	ALKDINREB(finish)	234	B019201003	210
ADSWP(finish)	249	ALKDINRED60(finish)	233	B019201032	210
AECP(finish)	197	ALKDINRES60(finish)	230	B019201093	210
aescE(finish)	196	ALKDINRESCS60SSS	234	B019301003	210
aescK(finish)	196	ALKDINRL60(finish)	232	B019301032	210
AFB(150/200)(19/25)(finish)	250	ALKHZB(finish)	229	B019301093	210
AFB15019(finish)	250	ALKHZS(finish)	229	B046515003	210
AFO(size)(finish)	247	ALKINTBATHFD30	248	B046515034	210
AFP(size)(finish)	195	ALKINTBATHFD60	248	B046515093	210
AFS(size)(finish)	247	ALKINTdead3lkfD30	248	B046815003	210
AGB2XT25E(finish)	238	ALKINTdead3lkfD60	248	B046815034	210
AGB2XT25WC(finish)	238	ALKINTdeadfD30	248	B046815093	210
AGB2XTE(finish)	236	ALKINTdeadfD60	248	C603F92525	240
agb2xtwc(finish)	236	ALKINTDINF30	248	C603F93030	240
AGBE32CHJA	217	ALKINTDINF(30/60)(finish)	234	C620F92525	241
AGBH32(finish)	217	ALKINTDINF60	248	C620F93030	241
AGBH32SHD(finish)	217	ALKINTsashFD30	248	C630F90525	242
AGBMLE(finish)	237	ALKINTsashFD60	248	C630F90530	242
AGBMLWC(finish)	237	ALKREBS3LK(finish)	223	C603012525	240
AGBTE(finish)	239	ALKREBSE(finish)	223	C603013030	240
AGBT(finish)	239	ALKSASH3LK3(finish)	225	C603022525	240
AGBTWC(finish)	239	ALKSASH3LK25(finish)	225	C603022525KA	245
AH322(finish)	214	ALKSASH5LK3(finish)	226	C603023030	240
AH1433(finish)	215	ALKSASH5LK25(finish)	226	C603023030KA	245
AH42525(finish)	216	ALKSASHE3(finish)	226	C603062525	240
AHB80(finish)	252	ALKSASHE25(finish)	225	C603063030	240
AHCH(finish)	250	ALP332(finish)	253	C603082525	240
AHG111433(finish)	215	ALP2532(finish)	253	C603082525KA	245
AHPFR32FD30	247	ALP25322pn	253	C603083030	240
AHPFR32FD60	247	ALRCE3(finish)	219	C603083030KA	245
AHPFR43	247	ALRCE25(finish)	219	C603302525	240
AHPFR43FD30	247	Alrebce(finish)	223	C603302525KA	245
AHPFR43FD60	247	ALRTD(finish)	196	C603303030	240
AHPFR43FD60(6)	247	APH424(finish)	216	C603303030KA	245
AHPFRR43	247	APHBBF(size)(finish)	194	C603322525	240
AHPFRR43FD30	247	APH(size)(finish)	194	C603322525KA	245
AHPFRR43FD60(6)	247	APH(size)SQ(finish)	194	C603323030	240
AHR1433(finish)	215	APH(size)TBAR(finish)	194	C603323030KA	245
AL3(finish)	218	ARBKEY	251	C603722525	240
AL4(finish)	218	ARB(size)(finish)	251	C603722525KA	245
AL6(finish)	219	ARBT(finish)	251	C603723030	240
AL25(finish)	218	ARCA(finish)	252	C603723030KA	245
ALCE3(finish)	219	AS75AFDKCASSS	197	C603842525	240
ALCE25(finish)	219	AS75BCASSS	197	C603842525KA	245
ALINTFD30	247	AS75DASSS	197	C603843030	240
ALINTFD60	247	AS75FASSS	197	C603843030KA	245



C620012525	241	EACC309	209	FMR268(finish)	64
C620013030	241	EACC313	209	FMR272(finish)	60
C620022525	241	EACC406	208	FMR280(finish)	67
C620023030	241	EAESCUK5	206	FMR413PC	68
C620062525	241	EAESCUK9	206	FMR422(finish)	61
C620063030	241	EC02400009	208	FMR430(finish)	62
C620082525	241	EEFSCUK3	207	FMRE(finish)	70
C620083030	241	EEFSCUK4	207	FMRK(finish)	70
C620302525	241	EEFSCUK5	207	FMRWC(finish)	70
C620303030	241	EEK1ARW	205	FMS136USC	69
C620322525	241	EEK1AWH	205	FMS213(finish)	69
C620323030	241	EEK1BRW	205	FMS215(finish)	65
C620722525	241	EEK1BWH	205	FMS254(finish)	59
C620723030	241	EEK1CRW	205	FMS268(finish)	64
C620842525	241	EEK1CWH	205	FMS272(finish)	60
C620843030	241	EEK1DRW	205	FMS280(finish)	67
C630020525	242	EEK1DWH	205	FMS293(finish)	66
C630020530	242	EEK1ERW	205	FMS413SC	68
C630080525	242	EEK1EWH	205	FMS422(finish)	61
C630080530	242	EEK1FRW	205	FMS430(finish)	62
C630300525	242	EEK1FWH	205	FMSE(finish)	70
C630300530	242	EEK1GRW	205	FMSK(finish)	70
C630320525	242	EEK1GWH	205	FMSWC(finish)	70
C630320530	242	EEK1HRW	205	M27SN	123
C630720525	242	EEK1HWH	205	M46SNNP	127
C630720530	242	EEK2ARW	205	M53SNNP	126
C630840525	242	EEK2AWH	205	M60SN	123
C630840530	242	EEK2BRW	205	M63SNNP	126
CA00023030	243	EEK2BWH	205	M70SN	124
CA00023535	243	EEK2CRW	205	M73SNCP	128
CA00083030	243	EEK2CWH	205	M77CP	127
CA00083535	243	EEK2DRW	205	M78SNCP	128
CA00163030	243	EEK2DWH	205	M83SNNP	125
CA00163535	243	EEK2ERW	205	M85(finish)	125
CA00303030	243	EEK2EWH	205	M86(finish)	122
CA00303535	243	EEK2FRW	205	M90SCPC	130
CA00323030	243	EEK2GRW	205	M125SNCP	129
CA00323535	243	EEK2GWH	205	M191SNCP	129
CA00723030	243	EEK2HRW	205	MC25(finish)	122
CA00723535	243	EEK2HWH	205	MCESCE(finish)	131
CA00843030	243	ERIC901	208	MCESCK(finish)	131
CA00843535	243	ERIC902	208	MCWC(finish)	131
CA20023030	244	ERIC903	208	MESCE(finish)	131
CA20023535	244	ERIC904	208	MESCK(finish)	131
CA20083030	244	ERIC905	208	MH350SMK(finish)	22
CA20083535	244	ERIC907	208	MH400DMK(finish)	23
CA20163030	244	ERIC928	208	MH450KSMK(finish)	24
CA20163535	244	FCR133(finish)	56	MHBH50(finish)	189
CA20303030	244	FCR236(finish)	57	MHBH64(finish)	189
CA20303535	244	FCR272(finish)	60	MHBH75(finish)	189
CA20323030	244	FCR280(finish)	67	MHCBN128(finish)	185
CA20323535	244	FCR422(finish)	61	MHCBN160(finish)	185
CA20723030	244	FCRESCE(finish)	70	MHCBN320(finish)	186
CA20723535	244	FCRWC(finish)	70	MHCBR49(finish)	188
CA20843030	244	FCS213(finish)	69	MHCBS50(finish)	188
CA20843535	244	FCS215(finish)	65	MHCBW128(finish)	186
CTFMR133SC	152	FCS254(finish)	59	MHCBW160(finish)	187
CTFMR254SC	152	FCS268(finish)	64	MHCBW320(finish)	187
CTFMRESC	152	FCS293(finish)	66	MHCD1420(finish)	174
CTFMRKSC	152	FCS430(finish)	62	MHCD1530(finish)	174
CTFMRWCS	152	FCSESCE(finish)	70	MHCD1675(finish)	176
CTFMS254SC	152	FCSWC(finish)	70	MHCD17128(finish)	176
CTFMSESC	152	FMR133(finish)	56	MHCD17160(finish)	177
CTFMKSC	152	FMR236(finish)	57	MHCD17320(finish)	177
CTFMWCSC	152	FMR254(finish)	58	MHCH1338(finish)	179

MHCH1420(finish)	178	O12524ESC	80	SPM222SNCP	94
MHCH1532(finish)	178	OE50RMK(finish)	108	SPMESCE(finish)	97
MHCH17128(finish)	180	OE57RMK(finish)	114	SPMESCK(finish)	97
MHCH17160(finish)	180	OE58MMK(finish)	110	SPMWC(finish)	96
MHCH17320(finish)	181	OE59CMKWH(finish)	115	SPR160(finish)	86
MHCK1230(finish)	162	OE60RREMK(finish)	113	SPR165(finish)	87
MHCK1338(finish)	162	OE110(finish)	104	SPR170(finish)	88
MHCK1420(finish)	160	OE127(finish)	103	SPR180(finish)	89
MHCK1532(finish)	160	OE142MAB	104	SPRESCE(finish)	96
MHCK1675(finish)	163	OE144MAB	105	SPRESCK(finish)	96
MHCK1820(finish)	184	OE175MAB	105	SPRKWC(finish)	96
MHCK1935(finish)	184	OE177(finish)	103	SPRLWC(finish)	96
MHCK17128(finish)	163	OE178(finish)	102	SPRO218(finish)	90
MHCK17160(finish)	164	OE178L(finish)	106	SPROESCE(finish)	96
MHCK17320(finish)	164	OE178WC(finish)	107	SPROESCK(finish)	96
MHCL1338(finish)	166	OEC1176(finish)	191	SPROWC(finish)	96
MHCL1420(finish)	165	OEC1232(finish)	191	SPRWC(finish)	96
MHCL1532(finish)	165	OEC1238(finish)	191	SPWC(finish)	97
MHCL1675(finish)	166	OEEESCE(finish)	116	SPWCSN	97
MHCL17128(finish)	168	OEEESCK(finish)	116	T293CR(finish)	49
MHCL17160(finish)	168	OEOWC(finish)	116	T293R(finish)	49
MHCL17320(finish)	169	OERKE(finish)	116	T1967CR(finish)	30
MHCN17128(finish)	182	OEWK(finish)	116	T1967R5S(finish)	30
MHCN17160(finish)	182	S2ESCER(finish)	148	T2275L(finish)	40
MHCN17320(finish)	183	S2ESCES(finish)	148	T2275S(finish)	46
MHCR100(finish)	18	S2ESCKR(finish)	148	T2732S(finish)	50
MHCR200(finish)	20	S2ESCKS(finish)	148	T3089L(finish)	45
MHCR250(finish)	21	S2WCR(finish)	149	T3094LSC	42
MHCR500(finish)	19	S2WCS(finish)	149	T3095S5S(finish)	35
MHCS1420(finish)	170	S3ESCER(finish)	148	T3095S(finish)	35
MHCS1532(finish)	170	S3ESCKR(finish)	148	T3097S(finish)	50
MHCS1675(finish)	172	S3WCR(finish)	149	T3098CR(finish)	31
MHCS17128(finish)	172	S4ESCES(finish)	148	T3098L(finish)	43
MHCS17160(finish)	173	S4ESCESMB	149	T3098R5S(finish)	31
MHCS17320(finish)	173	S4ESCKS(finish)	148	T3099L(finish)	41
MHOWC(finish)	25	S4ESCKSMB	149	T4007S5S(finish)	36
MHPH725UB	183	S4WCS(finish)	149	T4007S(finish)	36
MHPHK225UB	183	S4WCSMB	149	T4084L(finish)	42
MHR200(finish)	20	S21R(finish)	142	TESCER5S(finish)	37
MHRE(finish)	25	S22R(finish)	142	TESCER(finish)	51
MHRKE(finish)	25	S23SSC	147	TESCES5S(finish)	37
MHRK(finish)	25	S24S(finish)	147	TESCES(finish)	44, 51
MHRWC(finish)	25	S25SBN	145	TESCKL(finish)	44
MHSR100(finish)	18	S26RMB	144	TESCKR5S(finish)	37
MHSR250(finish)	21	S28R(finish)	141	TESCKR(finish)	51
MHSR500(finish)	19	S32RSCPC	143	TESCKS5S(finish)	37
MHSRE(finish)	25	S33R(finish)	138	TESCKS(finish)	51
MHSRK(finish)	25	S34R(finish)	136	TWCL(finish)	44
MHSRKWC(finish)	25	S35R(finish)	137	TWCR5S(finish)	37
MHSRLWC(finish)	25	S36R(finish)	143	TWCR(finish)	51
MHSRWC(finish)	25	S37RBNPC	145	TWCS5S(finish)	37
ML3(finish)	238	S38RSCPC	144	TWCS(finish)	51
MWC(finish)	131	S40S(finish)	146	XT3095R5S(finish)	34
O15EE(finish)	81	S42R(finish)	139	XT4002CR(finish)	33
O15EK(finish)	81	S43R(finish)	140	XT4002R5S(finish)	33
O31WC15E(finish)	81	SP190(finish)	92	XT4002S5S(finish)	33
O6515E(finish)	76	SP203SN	92	XT4071CR(finish)	32
O6815E(finish)	79	SP216(finish)	94	XT4071R5S(finish)	32
O8015E(finish)	76	SP217(finish)	91	XT4071S5S(finish)	32
O9215E(finish)	77	SPC193SN	95		
O9315E(finish)	79	SPCESCE(finish)	97		
O9615E(finish)	77	SPCESCK(finish)	97		
O10015EMB	80	SPCWC(finish)	97		
O10815E(finish)	78	SPESCE(finish)	97		
O10917E(finish)	78	SPESCK(finish)	97		
O12324EMB	81	SPM167CRCP	95		



# INDEX

## A

Absolute EvoKit 202, 206  
Ace, Oro & Oro 81  
Adra, Tupai 49  
AGB  
    Cylinders 240-246  
    Hinges 217  
    Magnetic Locks 236-239  
Alabama, Status 140  
Alaska, Status 144  
Alba, Oro & Oro 79  
Allia, Forme 66  
Ancon, Mediterranean 127  
Andretta, Senza Pari 86  
Aria, Oro & Oro 80  
Arizona, Status 142  
Artemide, Forme 69  
Asti, CleanTouch 152  
Asti, Forme 58-59

## B

Backplates, Cabinet Hardware 185-189  
    Narrow Backplates 185-186  
    Round Backplates 188  
    Square Backplates 188  
    Wide Backplates 185-186  
Barcelona, Mediterranean 122  
Bathroom Lock 224  
Bathroom Turn & Release  
    CleanTouch 152  
    Forme 70  
    Mediterranean 131  
    Millhouse Brass 25  
    Old English 116  
    Oro & Oro 81  
    Senza Pari 96-97  
    Status 149  
    Tupai 37, 44, 51  
Battersea, Cabinet Hardware 165-169  
Bianca, Senza Pari 95  
Bolts 251  
Boston, Forme 61  
Boulton, Millhouse Brass 22  
Bridlington, Old English 114

## C

Cabinet Hardware 154-191  
    Backplates 185-189  
    Cylinder Knobs 160, 165, 170,  
    174, 178, 184  
    Finger Pulls 162, 166, 179  
    Hinges 189  
    Pull Handles 163-164,  
    168-169,  
    172-173,

Round Knobs

Square Knobs  
T-Bar Knobs

California, Status 147  
Cambridge, Old English 105  
Canha, Tupai 36  
Carolina, Status 139  
Cartelle, Tupai 42  
Cartwright, Millhouse Brass 20  
Chrysler, Cabinet Hardware 174-177  
CleanTouch 150-153  
Colchester, Old English 103  
Colorado, Status 136  
Commercial Hardware 192-197  
Concealed  
    Concealed Euro Escutcheon 70  
    Concealed Key Escutcheon 70  
    Concealed Hinge 217  
    Concealed Rose 18-21, 30-33,  
    35-36, 46, 49,  
    56-57, 59-69  
    Concealed WC Turn & Release 70  
Corsica, Mediterranean 123  
Covas, Tupai 32  
Covela, Tupai 33  
Crompton, Millhouse Brass 18  
Crystal, Forme 64  
Crystal, Senza Pari 95  
Cylinders 240-246  
    15 Pin key to key cylinders 243  
    15 Pin key to turn cylinders 244  
    5 Pin double cylinder key to key 240  
    5 Pin key to turn cylinder 241  
    5 Pin keyed alike key to key cylinder 245  
    5 Pin single cylinders 242

## D

Dakota, Status 143  
Darrio, Senza Pari 90  
Davoli, Senza Pari 94  
Deadbolts 220, 221  
Deadlocks 227-228  
    3 Lever Deadlock 227  
    5 Lever Deadlock 228  
DIN Locks  
    DIN Bathroom Lock 231  
    DIN Deadlocks 233  
    DIN Escape Sashlocks 234  
    DIN Intumescent Kit 234  
    DIN Latch 232  
    DIN Locks 230-234  
    DIN Night Latch 233  
    DIN Rebate Kit 234

176-177,  
180-185  
160, 165, 170,  
174, 178, 184  
162  
166, 172, 176,  
179

DIN Sashlock	230
Disc Signage	197
Door Closer	196
Door Guard	252
Door Stops	249
Door Stops, Commercial Hardware	195
Durham, Old English	103

## E

Edison, Millhouse Brass	23
Eiffel, Cabinet Hardware	160-164
Elisse, Senza Pari	94
Elle, Forme	57
Empire, Cabinet Hardware	182-183
Ermetika Pocket Doors	198-211
Euro Deadlock	227-228
Euro Escutcheons	
CleanTouch	152
Forme	70
Mediterranean	131
Millhouse Brass	25
Old English	116
Oro & Oro	81
Senza Pari	96-97
Status	148-149
Tupai	37, 44, 51
Euro Sashlock	225-226
EvoKit	202, 204
EvoKit Fire	202, 207

## F

Fasana, Senza Pari	87
Finger Plates	195
Florida, Status	143
Flush Bolts	250
Foglia, Forme	60
Forme	52-70
Frana, Oro & Oro	79

## G

Galassia, Oro & Oro	78
Gibraltar, Mediterranean	125
Ginevra, Forme	62
Giovanni, Senza Pari	92
Guido, Senza Pari	92

## H

Handrail Brackets	252
Hargreaves, Cabinet Hardware	184
Harrison, Millhouse Brass	24
Harrogate, Old English	110
Hawaii, Status	144
Hinges	189, 214-217
Concealed Hinges	217
Cabinet Hardware Hinges	189
Fire-rated Hinges	214-215
Hooks	250
Horizontal Locks	229

## I

Ibiza, Mediterranean	127
Indiana, Status	138
Intumescent	247-248
Intumescent Hinge Pad	247
Intumescent Latch Kits	247
Intumescent Lock Kits	248
Intumescent Strip	247
Ivy, Oro & Oro	77

## J

Jamb	205
------	-----

## K

Kansas, Status	147
Key Escutcheons	
CleanTouch	152
Forme	70
Mediterranean	131
Millhouse Brass	25
Old English	116
Oro & Oro	81
Senza Pari	96-97
Status	148-149
Tupai	37, 44, 51
Kick Plates, Commercial Hardware	195

## L

Latch Packs	253
Laviano, Senza Pari	89
Lever on Backplate	106
Lincoln, Cabinet Hardware	191
Lorena, Forme	69

## M

Magnetic Locks	236-239
Magnetic Bathroom Lock	236-237
Magnetic Door Catch	239
Magnetic Euro Sashlock	236-237
Magnetic Narrow Locks	238
Malaga, Mediterranean	123
Malta, Mediterranean	122
Marseille, Mediterranean	124
Mason, Millhouse Brass	19
Mediterranean	118-131
Messina, Mediterranean	126
Millhouse Brass	14-25
Millhouse Brass Cabinet Hardware	154-189
Milly, CleanTouch	152
Milly, Forme	56
Monaco, Mediterranean	128
Montana, Status	146
Monza, Forme	68
Mortice Knobs	22-24, 108-115
Mortice Latches	218-219
Mortice Locks	224-229

## N

Naxos, Forme	65
--------------	----

Nebraska, Status 141  
Nevada, Status 142  
Newton, Cabinet Hardware 183

## O

Oia, Oro & Oro 80  
Oklahoma, Status 145  
Old English 98-117  
Old English Cabinet Hardware 191  
Olimpia, Forme 67  
Oran, Mediterranean 128  
Oro & Oro 71-81  
Oxford, Old English 105

## P

Paddington, Cabinet Hardware 170-173  
Palermo, Mediterranean 126  
Panela, Tupai 41  
Panetti, Senza Pari 91  
Pennington, Cabinet Hardware 178-181  
Portel, Tupai 34-35  
Pull Handles  
    Cabinet Hardware 163-164,  
    168-169,  
    172-173,  
    176-177,  
    180-185  
    Commercial Hardware 194

## R

Rebate Kits 223, 234  
Return to Door Lever 196  
Richmond, Old English 104  
Rillo, Tupai 40, 46  
Ripon, Old English 108  
Roller Catches 252  
Rosarno, Senza Pari 88

## S

Sabrosa, Tupai 42  
Santorini, Mediterranean 130  
Sashlocks 225-226  
    3 Lever Sashlock 225  
    5 Lever Sashlock 226  
Senza Pari 82-97  
Sienna, Oro & Oro 77  
Skipton, Old English 115  
Skywalker, Oro & Oro 76  
Smart Latches & Deadbolts 222  
Snib & Turn / Release  
    CleanTouch 152  
    Forme 70  
    Mediterranean 131  
    Millhouse Brass 25  
    Old English 116  
    Oro & Oro 81  
    Senza Pari 96-97

Status 149  
Tupai 37, 44, 51  
Status 132-149  
Stephenson, Millhouse Brass 21  
Stradi, Oro & Oro 78

## T

Tavira, Tupai 31,43  
Tennessee, Status 145  
Texas, Status 137  
Thomson, Cabinet Hardware 183  
Tobar, Tupai 45  
Torrao, Tupai 30  
Toulon, Mediterranean 129  
Tubular Mortice Deadbolts 220-221  
Tubular Mortice Latches 218-219  
Tunis, Mediterranean 129  
Tupai 26-51  
Turis, Tupai 50

## U

Unica, Oro & Oro 76

## V

Valbona, Tupai 50  
Valencia, Mediterranean 125

## W

Warwick, Old English 102, 106-107  
Watson, Cabinet Hardware 184  
WC Turn & Release  
    CleanTouch 152  
    Forme 70  
    Mediterranean 131  
    Millhouse Brass 25  
    Old English 116  
    Oro & Oro 81  
    Senza Pari 96-97  
    Status 149  
    Tupai 37, 44, 51  
Whitby, Old English 113  
Winchester, Cabinet Hardware 191  
Wrexham, Old English 104



# CHOOSING YOUR IRONMONGERY

---

We believe the finish matters, and this factor makes the biggest difference to the final atmosphere created by the ironmongery within an interior. Therefore we recommend, you choose the finish of your ironmongery before going on to consider the style you require and then concluding with the functionality aspects.

Why not browse the finish inspiration on pages 6 to 13 to help you make a decision? Looking at real homes often helps - take a look at the case study pages 254 to 263. Within each finish range there are multiple options of modern, flush, minimal, contemporary and traditional ironmongery styles - something for every taste. Each period of house, from Victorian and Georgian to new build and contemporary homes, has a very particular feel to the building and environment. When deciding to replace door furniture it is important to consider this factor. Certain finishes will also lend themselves more than others to different periods of homes, for example Satin Brass within a minimal, classy and modern home, and Antique Brass in a characterful traditional home.

Perhaps one of the most basic and functional items to choose are your hinges, however, these still matter, and especially the finish of these! The type of hinges you choose will depend upon a number of factors...

- Style of the door
- The door frame
- The weight of the door

Typically, panelled doors would be fitted with butt hinges. A butt hinge is designed to be cut into the frame and the door so that is largely hidden from view when the door is closed. Thought should be given to the weight of the door in question as heavier doors may require additional hinges or a larger size hinge.

Fire doors will require a fire tested hinge. There are several finish focused options of pages 214-215. The size and number of hinges is determined by the size of the door. For a common domestic application door we would recommend 3no. X 3" hinges. If you have a fire door you should use 3no. X 4" Hinges. You should also use 4" hinges if your existing doors have 4" hinges to keep the same character within the door set.

You will need to consider the purpose of the door and whether it needs a locking mechanism. Generally, but not always, internal doors are not locked so a standard latch (non-locking) or latch and turn and release (commonly used on bathroom doors) would be sufficient. A standard latch is simple to use and only requires the door handle to be pushed down for the door to open. The size of the latch required is determined by how far into the door you would like the door handle to sit. If an internal door does need a locking facility, a standard 3 lever lock would be an option to consider. If a fire door is used, fire tested latches and locks must be fitted with intumescent pads as the fire test specifies.

Consideration will need to be given to whether a door knob or lever handle is preferred for opening and closing the door. Levers are available in square or round rose or on backplate. Square rose is a very popular option in modern style interiors, while round rose is a contemporary or classic alternative. Levers on backplate are often regarded as a more traditional option.

## SUPPLY POLICY

---

We distribute our quality products through a strong network of registered stockists including trade and retail outlets throughout the UK. This includes Architectural Ironmongers, Builders Merchants, Door Retailers, other Independent Shops and online stockists.

Get in touch with to find out where your nearest stockist is!  
Call 0800 9020 486 or email [sales@atlanticgb.com](mailto:sales@atlanticgb.com).



# MAINTENANCE & CARE GUIDE

---

Our unique and bespoke finishes have been carefully crafted and developed over many years. We are proud to offer a complete range of hand-applied, quality, finish-focused products which provide customers with the option to create a full matching door set in a huge range of trending colours.

We do not recommend using our products externally, unless they are brass based. Zamak products would deteriorate in a matter of weeks or months due to extreme temperature change. By contrast, Solid Brass-based door handles and knobs will last for many years under normal external circumstances. We do not recommend using our products externally in coastal areas due to the high levels of atmospheric salt, as this will rust or tarnish most finishes.

In the unusual event of products failing mechanically, we will replace it free of charge, providing you can supply us with the faulty product and a receipt to show proof of purchase. If the items are not fitted in accordance with the fitting instructions, in a correct application, this may not apply.

All our products have a bespoke applied finish, and we recommend regular cleaning with a clean, moist, soft cloth. If necessary, you may moisten the cloth, with water. Any form of chemical cleaner could permanently damage the finish. Under no circumstance should you use an abrasive/hard tool, chemical, acidic or abrasive substance to clean our products. The finish may chip or scratch if subjected to impact from sharp items such as keys and jewellery; rings in particular. Atlantic UK retain the right to send items away for chemical testing to analyse if the product has come into contact with any abrasive or chemical substance before issuing replacements.

Please be aware that environments where there is high concentrations of chemicals in the air, for example from use of low quality paint or corrosive agents, corrosion and damage may occur to the surface of the hardware. Our products should therefore not be fitted in such environments, until the high concentration of chemicals in the air have subsided.

We recommend periodically oiling and cleaning any moving parts on all products to ensure they perform to their full capacity, and to remove any harmful deposits that build up on the surfaces. This will aid protection from environmental factors.

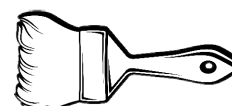
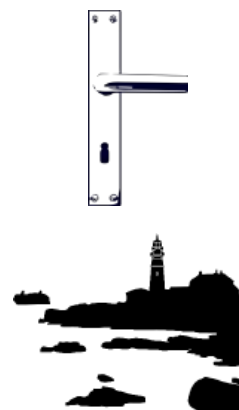

View our full Care Instructions here:



## FITTING ADVICE

---

The fixing kits supplied with our products are bespoke and carefully crafted specifically for their coordinating product. We would always recommend that a pilot hole is drilled, especially into hard woods, for all our fixings. Ideally it is suggested that screws are rubbed with candle-wax before fitting to ease the application. Please take the utmost care when fitting our screws to preserve the finish. We recommend that along with drilling a pilot hole, a well-fitting screwdriver should be used. Please avoid fixing by way of an impact driver or drill operated screwdriver, due to the hand-made nature of the fixings. Extra screws can be purchased, to replace lost or damaged screws. Please enquire for further details.

View our Fitting Instructions here:



If you have any questions, please email [sales@atlanticgb.com](mailto:sales@atlanticgb.com).



All sizes shown are approximate and we reserve the right to change them where necessary and without notice. Colours may vary from the actual products shown due to photography and print techniques. Finishing on some ranges may vary slightly from one batch to another, due to the hand finishing technique. All of our zamak and zinc alloy designer levers are designed for internal use only, and therefore the guarantee is voided if fitted externally. All products should be comprehensively checked before fitting commences.

# CONDITIONS OF SALE

## 1. INTERPRETATION

1.1 The definitions and rules of interpretation in this condition apply in these conditions.

Buyer: the person, firm or company who purchases the Goods from the Supplier.

Contract: any contract between the Supplier and the Buyer for the sale and purchase of the Goods, incorporating these conditions.

Goods: any goods agreed in the Contract to be supplied to the Buyer by the Supplier (including any part or parts of them).

Supplier: Chase Atlantic LTD, a Limited Company, trading Atlantic UK.

1.2 A reference to a particular law is a reference to it as it is in force for the time being taking account of any amendment, extension, application or re-enactment and includes any subordinate legislation for the time being in force made under it.

1.3 Words in the singular include the plural and in the plural include the singular.

1.4 A reference to one gender includes a reference to the other gender.

1.5 Condition headings do not affect the interpretation of these conditions.

## 2. APPLICATION OF TERMS

2.1 Subject to any variation under condition 2.3 the Contract shall be on these conditions to the exclusion of all other terms and conditions (including any terms or conditions which the Buyer purports to apply under any purchase order, confirmation of order, specification or other document).

2.2 No terms or conditions endorsed on, delivered with or contained in the Buyer's purchase order, confirmation of order, specification or other document shall form part of the Contract simply as a result of such document being referred to in the Contract.

2.3 These conditions apply to all the Supplier's sales (other than sales to consumers) and any variation to these conditions and any representations about the Goods shall have no effect unless expressly agreed in writing and signed by a partner of the Supplier. The Buyer acknowledges that it has not relied on any statement, promise or representation made or given by or on behalf of the Supplier which is not set out in the Contract. Nothing in this condition shall exclude or limit the Supplier's liability for fraudulent misrepresentation.

2.4 Each order or acceptance of a quotation for Goods by the Buyer from the Supplier shall be deemed to be an offer by the Buyer to buy Goods subject to these conditions.

2.5 No order placed by the Buyer shall be deemed to be accepted by the Supplier until a written acknowledgement of order is issued by the Supplier or (if earlier) the Supplier delivers the Goods to the Buyer.

2.6 Any quotation is given on the basis that no Contract shall come into existence until the Supplier despatches an acknowledgement of order to the Buyer. Any quotation is valid for a period of 30 days only from its date, provided that the Supplier has not previously withdrawn it.

2.7 In the event that the Supplier agrees to accept the return of Goods which have been ordered by the Buyer in error, the Buyer undertakes to pay to the Supplier a reasonable fee for the expense incurred by the Supplier in handling the return, which shall be no less than 25% of the value of the Goods returned.

## 3. DESCRIPTION

The quantity and description of the Goods shall be as set out in the Supplier's quotation or acknowledgement of order.

## 4. DELIVERY

4.1 Unless otherwise agreed in writing by the Supplier, delivery of the Goods shall take place at the Supplier's place of business.

4.2 Any dates specified by the Supplier for delivery of the Goods are intended to be an estimate and time for delivery shall not be made of the essence by notice. If no dates are so specified, delivery shall be within a reasonable time.

4.3 Subject to the other provisions of these conditions the Supplier shall not be liable for any direct, indirect or consequential loss (all three of which terms include, without limitation, pure economic loss, loss of profits, loss of business, depletion of goodwill and similar loss), costs, damages, charges or expenses caused directly or indirectly by any delay in the delivery of the Goods (even if caused by the Supplier's negligence), nor shall any delay entitle the Buyer to terminate or rescind the Contract unless the Buyer has given the Supplier 21 days written notice, provided that, if delivery occurs within such notice period the notice shall be void and delivery shall be deemed to have taken place.

4.4 If for any reason the Buyer fails to accept delivery of any of the Goods when they are ready for delivery, or the Supplier is unable to deliver the Goods on time because the Buyer has not provided appropriate instructions, documents, licences or authorisations:

4.4.1 risk in the Goods shall pass to the Buyer (including for loss or damage caused by the Supplier's negligence);

4.4.2 the Goods shall be deemed to have been delivered; and

4.4.3 the Supplier may store the Goods until delivery, whereupon the Buyer shall be liable for all related costs and expenses (including, without limitation, rehandling, storage, insurance and redelivery costs).

4.5 The Supplier may deliver the Goods by separate instalments. Each separate instalment shall be invoiced and paid for in accordance with the provisions of the Contract.

4.6 Each instalment shall be a separate Contract and no cancellation or termination of any one Contract relating to an instalment shall entitle the Buyer to repudiate or cancel any other Contract or instalment.

## 5. NON-DELIVERY/ FAILURE TO FIT OR INSTALL

5.1 The quantity of any consignment of Goods as recorded by the Supplier on despatch from the Supplier's place of business shall be conclusive evidence of the quantity received by the Buyer on delivery unless the Buyer can provide conclusive evidence proving the contrary.

5.2 The Supplier shall not be liable for any non-delivery of Goods (even if caused by the Supplier's negligence) unless the Buyer gives written notice to the Supplier of the non-delivery within 7 days of the date when the Goods would in the ordinary course of events have been received.

5.3 The Supplier shall not be liable to the Buyer for any failure to fit or install the Goods correctly if such failure arises as a result of the Buyer's failure to order Goods of the correct specification for the fitting or installation.

5.4 Any liability of the Supplier for non-delivery of the Goods shall be limited to replacing the Goods within a reasonable time or issuing a credit note at the pro rata Contract rate against any invoice raised for such Goods.

## 6. RISK/TITLE

6.1 The Goods are at the risk of the Buyer from the time of delivery.

6.2 Ownership of the Goods shall not pass to the Buyer until the Supplier has received in full (in cash or cleared funds) all sums due to it in respect of:

6.2.1 the Goods; and

6.2.2 all other sums which are or which become due to the Supplier from the Buyer on any account.

6.3 Until ownership of the Goods has passed to the Buyer, the Buyer shall:

6.3.1 hold the Goods on a fiduciary basis as the Supplier's bailee;

6.3.2 store the Goods (at no cost to the Supplier) separately from all other goods of the Buyer or any third party in such a way that they remain readily identifiable as the Supplier's property; 6.3.3 not destroy, deface or obscure any identifying mark or packaging on or relating to the Goods; and

6.3.4 maintain the Goods in satisfactory condition and keep them insured on the Supplier's behalf for their full price against all risks to the reasonable satisfaction of the Supplier. On request the Buyer shall produce the policy of insurance to the Supplier.

6.4 The Buyer may resell the Goods before ownership has passed to it provided that any sale shall be effected in the ordinary course of the Buyer's business at full market value.

6.5 The Buyer's right to possession of the Goods shall terminate immediately if:

6.5.1 the Buyer has a bankruptcy order made against him or makes an arrangement or composition with his creditors, or otherwise takes the benefit of any statutory provision for the time being in force for the relief of insolvent debtors, or (being a body corporate) convenes a meeting of creditors (whether formal or informal), or enters into liquidation (whether voluntary or compulsory) except a solvent voluntary liquidation for the purpose only of reconstruction or amalgamation, or has a receiver and/or manager, administrator or administrative receiver appointed of its undertaking or any part thereof, or documents are filed with the court for the appointment of an administrator of the Buyer or notice of intention to appoint an administrator is given by the Buyer or its directors or by a qualifying floating charge holder (as defined in paragraph 14 of Schedule B1 to the Insolvency Act 1986), or a resolution is passed or a petition presented to any court for the winding-up of the Buyer or for the granting of an administration order in respect of the Buyer, or any proceedings are commenced relating to the insolvency or possible insolvency of the Buyer; or

6.5.2 the Buyer suffers or allows any execution, whether legal or equitable, to be levied on his/its property or obtained against him/it, or fails to observe or perform any of his/its obligations under the Contract or any other contract between the Supplier and the Buyer, or is unable to pay its debts within the meaning of section 123 of the Insolvency Act 1986 or the Buyer ceases to trade; or 6.5.3 the Buyer encumbers or in any way charges any of the Goods.

6.6 The Supplier shall be entitled to recover payment for the Goods notwithstanding that ownership of any of the Goods has not passed from the Supplier.

6.7 The Buyer grants the Supplier, its agents and employees an irrevocable licence at any time to enter any premises where the Goods are or may be stored in order to inspect them, or, where the Buyer's right to possession has terminated, to recover them.

6.8 Where the Supplier is unable to determine whether any Goods are the goods in respect of which the Buyer's right to possession has terminated, the Buyer shall be deemed to have sold all goods of the kind sold by the Supplier to the Buyer in the order in which they were invoiced to the Buyer.

6.9 On termination of the Contract, howsoever caused, the Supplier's (but not the Buyer's) rights contained in this condition 6 shall remain in effect.

## 7. PRICE

7.1 Unless otherwise agreed by the Supplier in writing, the price for the Goods shall be the price set out in the Supplier's price list published on the date of delivery or deemed delivery and the Supplier reserves the right to vary the Supplier's price list without notice to the Buyer although the Supplier will

confirm its price list by request.

7.1 Unless otherwise stated, the price for the Goods shall be exclusive of any value added tax and all costs or charges in relation to packaging, loading, unloading, carriage and insurance, all of which amounts the Buyer shall pay in addition when it is due to pay for the Goods.

## 8. PAYMENT

8.1 Payment of the price for the Goods is due in pounds sterling.

8.2 Unless credit facilities are offered by the Supplier payment shall be prior to delivery.

8.3 If credit facilities are offered by the Supplier payment shall be due 30 days from the date of the Supplier's invoice following delivery.

8.4 If credit facilities are agreed between the parties and the Buyer exceeds the agreed level of credit, the excess shall be payable immediately.

8.5 Time for payment shall be of the essence.

8.6 No payment shall be deemed to have been received until the Supplier has received cleared funds.

8.7 Without prejudice to any other rights or remedies available to the Supplier, where a Buyer's cheque for payment for the Goods is dishonoured, the Supplier may charge the Buyer an administration fee of up to £25 for the related costs incurred by the Supplier.

8.8 Where any payment is overdue the Supplier may:

8.8.1 withhold delivery of any other Goods ordered by the Buyer; and

8.8.2 charge to the Buyer the reasonable collection and debt recovery costs incurred in seeking to recover such overdue payment including but not limited to an administration charge of a minimum of £25.

8.9 Where the parties agree a payment schedule and the Buyer defaults on any part of the payment schedule, the payment schedule shall be void and any amount owed by the Buyer to the Supplier shall immediately become payable, including any previously waived fees or interest.

8.10 The Buyer shall make all payments due under the Contract in full without any deduction whether by way of set-off, counterclaim, discount, abatement or otherwise unless the Buyer has a valid court order requiring an amount equal to such deduction to be paid by the Supplier to the Buyer.

8.11 If the Buyer fails to pay the Supplier any sum due pursuant to the Contract, the Buyer shall be liable to pay interest to the Supplier on such sum from the due date for payment at the annual rate of 8% above the base lending rate from time to time of the Royal Bank of Scotland Plc, accruing on a daily basis until payment is made, whether before or after any judgment. The Supplier reserves the right to claim compensation and interest under the Late Payment of Commercial Debts (Interest) Act 1998.

8.12 All payments payable to the Supplier under the Contract shall become due immediately on its termination despite any other provision.

## 9. QUALITY

9.1 The Supplier warrants that (subject to the other provisions of these conditions) on delivery the Goods shall be of satisfactory quality within the meaning of the Sale of Goods Act 1979.

9.2 The Supplier shall not be liable for a breach of the warranty in condition 9.1 unless:

9.2.1 the Buyer gives written notice of the defect to the Supplier, and, if the defect is as a result of damage in transit to the carrier, within 7 days of the time when the Buyer discovers or ought to have discovered the defect; and

9.2.2 the Supplier is given a reasonable opportunity after receiving the notice of examining such Goods and the Buyer (if asked to do so by the Supplier) returns such Goods to the Supplier's place of business for the examination to take place there.

9.3 The Supplier shall not be liable for a breach of the warranty in condition 9.1 if:

9.3.1 the Buyer makes any further use of such Goods after giving such notice; or

9.3.2 the defect arises because the Buyer failed to follow the Supplier's oral or written instructions as to the storage, installation, commissioning, use or maintenance of the Goods or (if there are none) good trade practice; or 9.3.3 the Buyer alters or repairs such Goods without the written consent of the Supplier.

9.4 Subject to condition 9.2 and condition 9.3, if any of the Goods do not conform with the warranty in condition 9.1 the Supplier shall at its option repair or replace such Goods (or the defective part) or refund the price of such Goods at the pro rata Contract rate provided that, if the Supplier so requests, the Buyer shall, at the Buyer's expense, return the Goods or the part of such Goods which is defective to the Supplier.

9.5 The Supplier does not warrant that any goods are fit for particular purpose unless specifically so warranted in writing, and is not liable for any fixings, fittings, cutting, adjustments or specific site conditions, or contractor's works on behalf of the Buyer or third party, and not in the direct employ of the Supplier.

9.6 If the Supplier complies with condition 9.4 it shall have no further liability for a breach of the warranty in condition 9.1 in respect of such Goods.

9.7 Any Goods replaced shall belong to the Supplier and any repaired or replacement Goods shall be guaranteed on these terms for the unexpired portion of the 12 month period.

## 10. LIMITATION OF LIABILITY

10.1 Subject to condition 4, condition 5 and condition 9, the following provisions set out the entire financial liability of the Supplier (including any liability for the acts or omissions of its employees, agents and sub-contractors) to the Buyer in respect of:

10.1.1 any breach of these conditions;

10.1.2 any use made or resale by the Buyer of any of the Goods, or of any product incorporating any of the Goods; and

10.1.3 any representation, statement or tortious act or omission including negligence arising under or in connection with the Contract.

10.2 All warranties, conditions and other terms implied by statute or common law (save for the conditions implied by section 12 of the Sale of Goods Act 1979) are, to the fullest extent permitted by law, excluded from the Contract.

10.3 Nothing in these conditions excludes or limits the liability of the Supplier:

10.3.1 for death or personal injury caused by the Supplier's negligence; or

10.3.2 under section 2(3), Consumer Protection Act 1987; or

10.3.3 for any matter which it would be illegal for the Supplier to exclude or attempt to exclude its liability or 10.3.4 for fraud or fraudulent misrepresentation.

10.4 Subject to condition 10.2 and condition 10.3:

10.4.1 the Supplier's total liability in contract, tort (including negligence or breach of statutory duty), misrepresentation, restitution or otherwise, arising in connection with the performance or contemplated performance of the Contract shall be limited to the Contract price of the goods in question; and

10.4.2 the Supplier shall not be liable to the Buyer for loss of profit, loss of business, or depletion of goodwill in each case whether direct, indirect or consequential, which arise out of or in connection with the Contract.

## 11. ASSIGNMENT

11.1 The Supplier may assign the Contract or any part of it to any person, firm or company.

11.2 The Buyer shall not be entitled to assign the Contract or any part of it without the prior written consent of the Supplier.

## 12. FORCE MAJEURE

The Supplier reserves the right to defer the date of delivery or to cancel the Contract or reduce the volume of the Goods ordered by the Buyer (without liability to the Buyer) if it is prevented from or delayed in the carrying on of its business due to circumstances beyond the reasonable control of the Supplier including, without limitation, acts of God, governmental actions, war or national emergency, acts of terrorism, protests, riot, civil commotion, fire, explosion, flood, epidemic, lock-outs, strikes or other labour disputes (whether or not relating to either party's workforce), or restraints or delays affecting carriers or inability or delay in obtaining supplies of adequate or suitable materials, provided that, if the event in question continues for a continuous period in excess of 60 days, the Buyer shall be entitled to give notice in writing to the Supplier to terminate the Contract.

## 13. GENERAL

13.1 Each right or remedy of the Supplier under the Contract is without prejudice to any other right or remedy of the Supplier whether under the Contract or not.

13.2 If any provision of the Contract is found by any court, tribunal or administrative body of competent jurisdiction to be wholly or partly illegal, invalid, void, voidable, unenforceable or unreasonable it shall to the extent of such illegality, invalidity, voidness, voidability, unenforceability or unreasonableness be deemed severable and the remaining provisions of the Contract and the remainder of such provision shall continue in full force and effect.

13.3 Failure or delay by the Supplier in enforcing or partially enforcing any provision of the Contract shall not be construed as a waiver of any of its rights under the Contract.

13.4 Any waiver by the Supplier of any breach of, or any default under, any provision of the Contract by the Buyer shall not be deemed a waiver of any subsequent breach or default and shall in no way affect the other terms of the Contract.

13.5 The parties to the Contract do not intend that any term of the Contract shall be enforceable by virtue of the Contracts (Rights of Third Parties) Act 1999 by any person that is not a party to it.

13.6 The formation, existence, construction, performance, validity and all aspects of the Contract shall be governed by English law and the parties submit to the non-exclusive jurisdiction of the English courts.

## 14. COMMUNICATIONS

14.1 All communications between the parties about the Contract shall be in writing and delivered by hand or sent by pre-paid first class post or sent by fax:

14.1.1 (in case of communications to the Supplier) to its registered office or such changed address as shall be notified to the Buyer by the Supplier; or

14.1.2 (in the case of the communications to the Buyer) to its registered office or such changed address as shall be notified to the Supplier by the Buyer.

THESE TERMS AND CONDITIONS SHALL ONLY APPLY TO BUSINESS TO BUSINESS TRANSACTIONS. IF YOU ARE PURCHASING GOODS AS A CONSUMER THESE TERMS AND CONDITIONS SHALL NOT APPLY TO YOUR PURCHASE.

atlantic uk<sup>®</sup>  
architectural hardware  
*the finish matters<sup>®</sup>*



---

0800 9020 486 | [sales@atlanticgb.com](mailto:sales@atlanticgb.com) | [www.atlantichandles.com](http://www.atlantichandles.com)

Atlantic UK, Unit 362 Street 7, Thorp Arch Estate, Wetherby, West Yorkshire, LS23 7FL

---